

**kts** ACCESSORI



CODICE e DESCRIZIONE CODE and DESCRIPTION	FINITURE FINISHINGS	€	PCS/BOX
<b>KNO11</b>			
Pomolo FUTURE 60x60 mm su rosetta 52x52 mm	CHS	32,25	1
	CHL	32,25	1
	PVD	39,20	1
<i>FUTURE knob 60x60 mm square rose 52x52 mm</i>			



<b>KNO12A</b>			
Pomolo FLASH 55x55 mm su rosetta 50x50 mm	CHS	35,10	1
	CHL	36,70	1
	GRF	45,00	1
<i>FLASH knob 55x55 mm square rose 50x50 mm</i>	NEO	38,00	1
	BAO	40,00	1



<b>KNO12B</b>			
Pomolo FLASH 65x65 mm su rosetta 50x50 mm	CHS	40,10	1
	CHL	41,70	1
	GRF	50,00	1
<i>FLASH knob 65x65 mm square rose 50x50 mm</i>	NEO	43,00	1
	BAO	45,00	1

<b>KNO13</b>			
Pomolo QUADRO 60x60 mm su rosetta 55x55 mm	CHS	72,10	1
	CHL	80,40	1
<i>QUADRO knob 60x60 mm square rose 55x55 mm</i>			

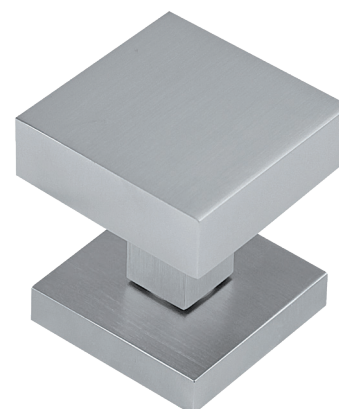

CODICE e DESCRIZIONE CODE and DESCRIPTION	FINITURE FINISHINGS	€	PCS/BOX
----------------------------------------------	------------------------	---	---------

## KN021

Pomolo BIN ø 70 mm su rosetta ø 50 mm	OLV	35,00	4
	BRY	39,00	4
	BRG	38,00	4
	CHS	36,50	4
<i>BIN knob ø 70 mm square rose ø 50 mm</i>			



## KNO17

Pomolo CORNER su rosetta ø 50 mm	OLV	36,30	1
	BRG	37,40	1
	CHS	38,00	1
<i>CORNER knob square rose ø 50 mm</i>			



## KNO09

Pomolo URANO ø 72 mm su rosetta ø 60 mm	OLV	39,00	1
	BRG	41,00	1
	CHL	48,00	1
	CHS	45,00	1
<i>URANO knob ø 72 mm square rose ø 60 mm</i>			



CODICE e DESCRIZIONE CODE and DESCRIPTION	FINITURE FINISHINGS	€	PCS/BOX
<b>KNO01</b>			
Pomolo IBISCO ø 70 mm su rosetta ø 80 mm	OLV	53,00	1
	BRG	55,00	1
	CHS	70,00	1
<i>IBISCO knob ø 70 mm square rose ø 80 mm</i>			



<b>KNO15</b>			
Pomolo DIAMANTE ø 70 mm su rosetta ø 80 mm	OLV	50,00	1
	BRG	52,00	1
	CHS	69,00	1
<i>DIAMANTE knob ø 70 mm square rose ø 80 mm</i>			



<b>KNO02</b>			
Pomolo NORWAY ø 70 mm su rosetta ø 80 mm	OLV	49,00	1
	BRG	51,00	1
	CHS	68,00	1
<i>NORWAY knob ø 70 mm square rose ø 80 mm</i>			



CODICE e DESCRIZIONE  
CODE and DESCRIPTION

FINITURE  
FINISHINGS

€

PCS/BOX

## KNO16

Pomolo NOVA ø 63 mm su rosetta ø 50 mm	OLV	39,00	1
	OSV	39,00	1
<i>NOVA knob ø 63 mm square rose ø 50 mm</i>	BRG	41,00	1
	CHS	45,00	1
	PVD	59,00	1



## KNO03

Pomolo GLOBE ø 67 mm su rosetta ø 51 mm	OLV	36,00	1
	BRG	38,00	1
	BRY	39,00	1
<i>GLOBE knob ø 67 mm square rose ø 50 mm</i>	CHS	42,00	1
	CHL	44,00	1
	PVD	65,00	1



## KNO10

Pomolo GLOBE 2 ø 56 mm su rosetta ø 50 mm	OLV	38,00	1
	BRG	40,00	1
	BRY	41,00	1
<i>GLOBE 2 knob ø 56 mm square rose ø 50 mm</i>	CHS	44,00	1
	CHL	46,00	1
	PVD	57,00	1



CODICE e DESCRIZIONE  
CODE and DESCRIPTION

FINITURE  
FINISHINGS

€

PCS/BOX

## KNK01

Battente IBISCO

OLV

158,00

1

BRY

163,00

1

*IBISCO knocker*

BRG

162,00

1

CHS

193,00

1



## KNK07

Battente LEONE

OLV

68,00

1

BRM

70,00

1

*LEONE knocker*

CHS

87,00

1



CODICE e DESCRIZIONE  
CODE and DESCRIPTION

FINITURE  
FINISHINGS

€

PCS/BOX

## KNK06

Battente AMERICA  
*AMERICA knocker*

OLV	142,00	1
BRG	146,00	1
CHS	192,00	1



## KNK05

Battente LIBERTY  
*LIBERTY knocker*

OLV	144,00	1
BRG	148,00	1
CHS	179,00	1



## KNK04

Battente NODE  
*NODE knocker*

OLV	115,00	1
CHS	120,00	1



# Maniglioni - Pull handles

CODICE e DESCRIZIONE  
CODE and DESCRIPTION

FINITURE  
FINISHINGS

€

PCS/BOX

**PUH026**

Maniglione IMPERO

*IMPERO Pull handle*

PCS/BOX 1

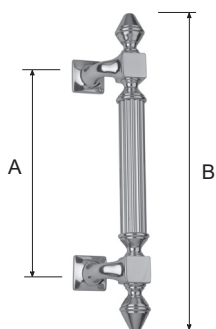

misure/sizes	OLV	BRG	BRY	PVD	FAN	CRS
A 230 B 360						
A 300 B 430						
A 370 B 500						
A 470 B 500						
A 570 B 700						

DISPONIBILE IN VARIE MISURE

AVAILABLE IN DIFFERENT SIZES

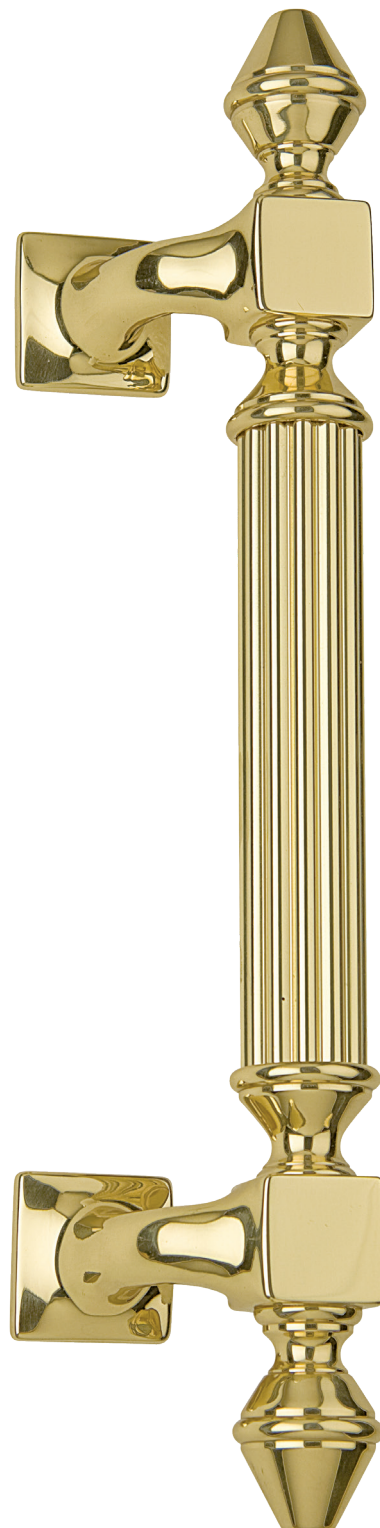



CODICE e DESCRIZIONE CODE and DESCRIPTION	FINITURE FINISHINGS	€	PCS/BOX
<b>PUH014</b>			
Maniglione MUSA	OLV		1
<i>MUSA Pull handle</i>	BRG		1
	BRY		1
	CHS		1
	CHL		1
	PVD		1



<b>PUH003</b>			
Maniglione CURVO	OLV		1
<i>CURVO Pull handle</i>	BRG		1
	BRY		1
	CHS		1
	CHL		1
	OLS		1
	CLS		1

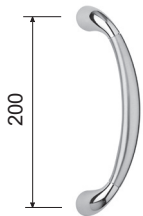

# Maniglioni - Pull handles

CODICE e DESCRIZIONE  
CODE and DESCRIPTION

FINITURE  
FINISHINGS

€

PCS/BOX

## PUH004

Maniglione DONKEY

OLV

104,00

1

BRG

106,00

1

*DONKEY Pull handle*

BRY

108,00

1

CHS

120,00

1

CHL

120,00

1

PVD

150,00

1



## PUH016

Maniglione CURVO BIG

BRG

89,00

1

BRY

91,00

1

*CURVO BIG Pull handle*

CHS

103,00

1

CHL

109,00

1

PVD

120,00

1

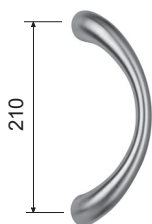

CODICE e DESCRIZIONE  
CODE and DESCRIPTION

FINITURE  
FINISHINGS

€

PCS/BOX

## PUH018

Maniglione IDEA	OLV	102,00	1
<i>IDEA Pull handle</i>	BRG	104,00	1
	BRY	105,00	1
	CHS	107,00	1
	CHL	108,00	1
	PVD	130,00	1



## PUH015

Maniglione RANDA	BRG	78,10	1
<i>RANDA Pull handle</i>	BRY	80,10	1
	CHS	89,30	1
	PVD	106,70	1



CODICE e DESCRIZIONE  
CODE and DESCRIPTION

FINITURE  
FINISHINGS

€

PCS/BOX

## PUH005

Maniglione BASIC  
*BASIC Pull handle*

CHS  
PVD

1  
1



## PUH001

Maniglione IBISCO  
*IBISCO Pull handle*

OLV  
BRG  
BRY  
CHS

184,00  
183,00  
186,00  
201,00

1  
1  
1  
1

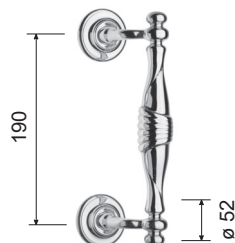

CODICE e DESCRIZIONE  
CODE and DESCRIPTION

FINITURE  
FINISHINGS

€

PCS/BOX

## PUH006

Maniglione PLAIN  
*PLAIN Pull handle*

OLV  
BRG  
BRY  
CHS  
CHL  
PVD

1  
1  
1  
1  
1  
1

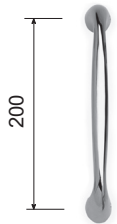

## PUH008

Maniglione WILLY  
*WILLY Pull handle*

OLS  
CLS

1  
1



CODICE e DESCRIZIONE  
CODE and DESCRIPTION

FINITURE  
FINISHINGS

€

PCS/BOX

## PUH019

Maniglione TOSCANA  
*TOSCANA Pull handle*

OLV  
BRG  
BRY  
BRP

1  
1  
1  
1

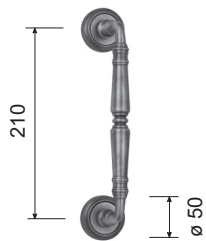

## PUH012A/B

Maniglione IBIZA  
*IBIZA Pull handle*

PCS/BOX 1



misure/sizes	CHL	CHS	PVD
A 160			
A 200			

DISPONIBILE IN VARIE MISURE  
AVAILABLE IN DIFFERENT SIZES



CODICE e DESCRIZIONE  
CODE and DESCRIPTION

FINITURE  
FINISHINGS

€

PCS/BOX

## PUH011

Maniglione PLANO  
*PLANO Pull handle*

CHS  
CHL  
CLS  
NEO

1  
1  
1  
1

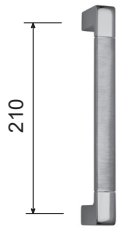

## PUH011B

Maniglione VEMA  
*VEMA Pull handle*

CHS  
CLS  
NEO

1  
1  
1

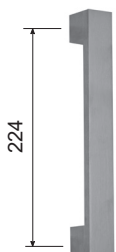

# Maniglioni alzanti

## Pull handles for sliding doors



CODICE e DESCRIZIONE  
CODE and DESCRIPTION

FINITURE  
FINISHINGS

€

PCS/BOX

### PUHA004

Maniglione alzante  
MEDEA SINGOLO  
con nicchia

*SINGLE Pull handle for sliding  
door with oval flush*

OLV	121,60	1
OSV	121,60	1
BRG	122,90	1
BRY	124,20	1
CHS	131,90	1
CHL	134,60	1

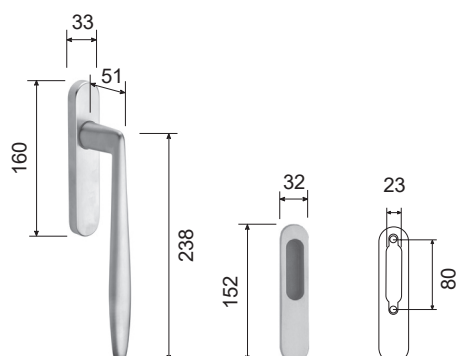

### PUHA004SET

Maniglione alzante  
MEDEA DOPPIO  
foro cilindro senza nicchia

*DOUBLE Pull handle  
for sliding door*

OLV	203,20	1
OSV	203,20	1
BRG	205,80	1
BRY	208,40	1
CHS	223,80	1
CHL	229,20	1

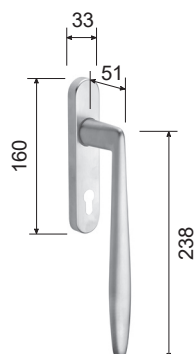



# Maniglioni alzanti

## Pull handles for sliding doors



CODICE e DESCRIZIONE CODE and DESCRIPTION	FINITURE FINISHINGS	€	PCS/BOX
<b>PUHA003</b>			
Maniglione alzante UNI SINGOLO con nicchia  <i>SINGLE Pull handle for sliding door with oval flush</i>	OLV	123,50	1
	OSV	123,50	1
	BRG	124,80	1
	BRY	126,10	1
	CHS	133,90	1
	CHL	136,50	1

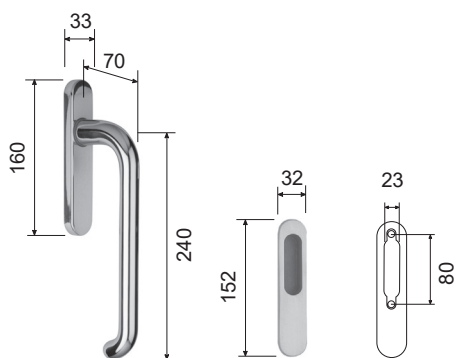

<b>PUHA003SET</b>			
Maniglione alzante UNI DOPPIO foro cilindro senza nicchia  <i>DOUBLE Pull handle for sliding door</i>	OLV	207,00	1
	OSV	207,00	1
	BRG	209,60	1
	BRY	212,20	1
	CHS	227,80	1
	CHL	233,00	1

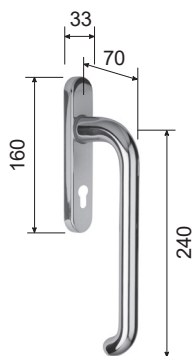

# Maniglioni alzanti

## Pull handles for sliding doors



CODICE e DESCRIZIONE  
CODE and DESCRIPTION

FINITURE  
FINISHINGS

€

PCS/BOX

### PUHA006

Maniglione alzante  
CURVO SINGOLO  
con nicchia

BRY  
CHS  
NEO

128,00  
132,65  
136,00

1  
1  
1

*SINGLE Pull handle for sliding door with oval flush*

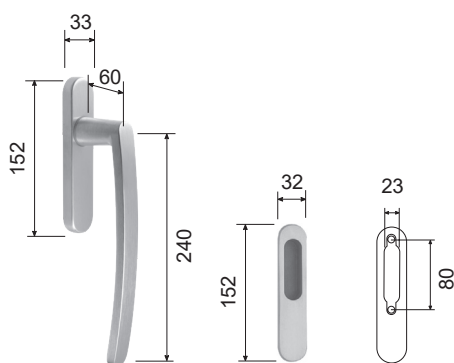

### PUHA006SET

Maniglione alzante  
CURVO DOPPIO  
foro cilindro senza nicchia

BRY  
CHS  
NEO



216,00  
225,30  
232,00

1  
1  
1

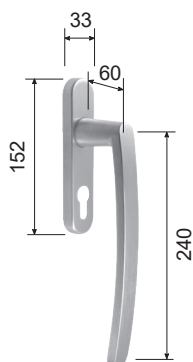

*DOUBLE Pull handle for sliding door*

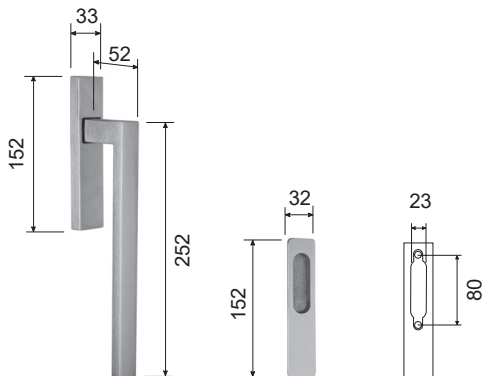

CODICE e DESCRIZIONE CODE and DESCRIPTION	FINITURE FINISHINGS	€	PCS/BOX
<b>PUHA001</b>			
Maniglione alzante QUBE SINGOLO con nicchia  <i>SINGLE Pull handle for sliding                      door with rectangular flush</i>	CHS	142,65	1

<b>PUHA001SET</b>			
Maniglione alzante QUBE DOPPIO foro cilindro senza nicchia  <i>DOUBLE Pull handle                      for sliding door</i>	CHS	240,30	1

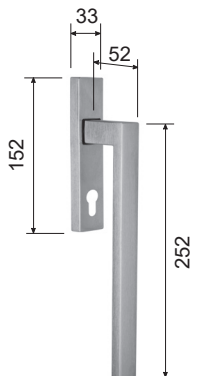



### PUHA005

Maniglione alzante  
BIBLO SINGOLO  
con nicchia

BRY	138,00	1
CHS	142,65	1
NEO	146,00	1

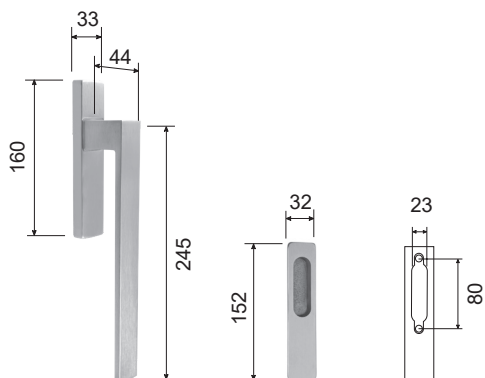
*SINGLE Pull handle for sliding door with rectangular flush*



### PUHA005SET

Maniglione alzante  
BIBLO DOPPIO  
foro cilindro senza nicchia

BRY	231,00	1
CHS	240,30	1
NEO	247,00	1

*DOUBLE Pull handle for sliding door*

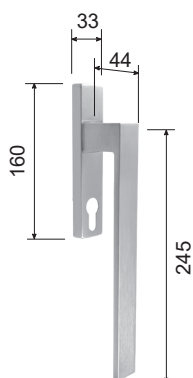

CODICE e DESCRIZIONE CODE and DESCRIPTION	FINITURE FINISHINGS	€	PCS/BOX	
<b>WC1RR08</b>				
Nottolino oliva libero/occupato per porta battente su rosetta tonda ø 45 mm  <i>Wc closer with round rose ø 45 mm</i>	OLV	20,50	5	
	BRG	24,00	5	
	BRY	25,00	5	
	CHS	22,00	5	
	CHL	22,50	5	
	PVD	31,00	5	
<b>WC2RR09</b>				
Nottolino farfalla libero/occupato per porta battente su rosetta tonda ø 50 mm  <i>Wc closer with round rose ø 50 mm</i>	OLV	22,50	5	
	BRG	26,00	5	
	BRY	27,00	5	
	CHS	24,00	5	
	CHL	24,50	5	
	PVD	33,00	5	
<b>WC1OR01</b>				
Nottolino oliva libero/occupato per porta battente su rosetta ovale 30x60 mm  <i>Wc closer with oval rose 30x60 mm</i>	OLV	22,50	5	
	BRG	26,00	5	
	BRY	27,00	5	
	CHS	24,00	5	
	CHL	24,50	5	
	PVD	33,00	5	
<b>WC4SR08</b>				
Nottolino quadro libero/occupato per porta battente su rosetta quadra 45x45 mm  <i>Wc closer with square rose 45x45 mm</i>	CHS	29,00	4	
	CHL	29,50	4	
<b>WC3SR07</b>				
Nottolino square libero/occupato per porta battente su rosetta quadra 50x50 mm  <i>Wc closer with square rose 50x50 mm</i>	CHS	34,00	4	
	CHL	34,50	4	
<b>WC3QR01</b>				
Nottolino square libero/occupato per porta battente su rosetta rettangolare 30x60 mm  <i>Wc closer with rectangular rose 30x60 mm</i>	CHL	35,50	4	
	CHS	35,00	4	

CODICE e DESCRIZIONE  
CODE and DESCRIPTION

FINITURE  
FINISHINGS

€

PCS/BOX

## DC01

Chiudiporta a molla

BRG

18,50

10

*Door closer spring*

BAO

18,00

10

NEO

18,00

10

F3S

18,10

10

F1S

17,50

10

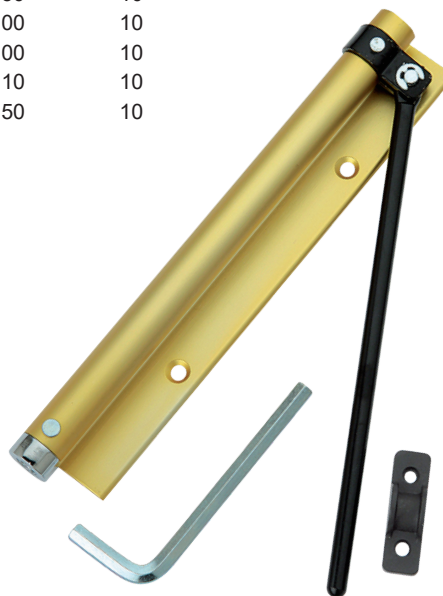
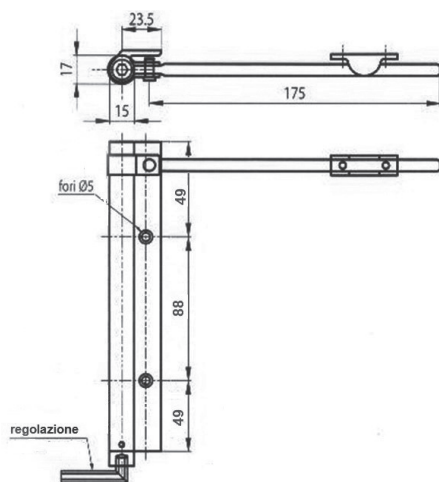

## HIN01

Cerniera a molla

BRG

41,10

2

DOPPIA AZIONE

BAO

40,20

2

*Spring hinge  
DUAL ACTION*

NEO

40,20

2

F3S

40,60

2

F1S

38,80

2

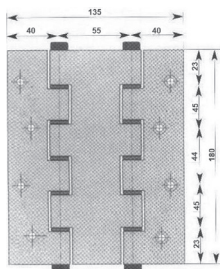

## HIN02

Cerniera a molla

BRG

28,10

2

AZIONE SINGOLA

F3S

27,30

2

*Spring hinge  
SINGLE ACTION*

F1S

26,20

2

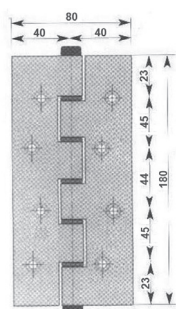

CODICE e DESCRIZIONE  
CODE and DESCRIPTION

FINITURE  
FINISHINGS

€

PCS/BOX

## GC01

Guidacinghia OVALE

*OVALE roller guide*

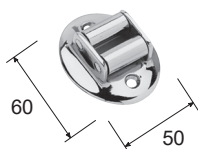

OLV	24,90	10
CHS	34,50	10
CHL	34,50	10
BRG	27,10	10



## GC02

Guidacinghia QUADRO

*QUADRO roller guide*

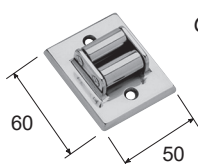

OLV	25,90	10
CHS	35,50	10
CHL	35,50	10
BRG	28,10	10

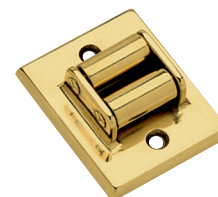

## CAV01

Copriavvolgibile TONDO

*TONDO belt shifter*

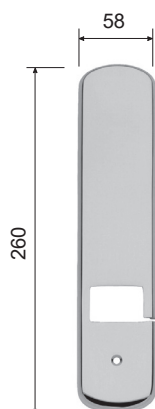

OLV	26,40	12
CHS	32,90	12
CHL	32,90	12
BRG	29,30	12



## CAV02

Copriavvolgibile QUADRO

*QUADRO belt shifter*



OLV	27,40	12
CHS	33,90	12
CHL	33,90	12
BRG	30,30	12

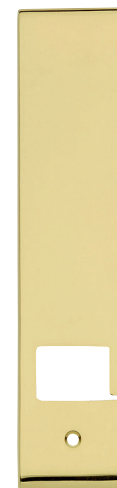

CODICE e DESCRIZIONE  
CODE and DESCRIPTION

€

PCS/BOX

## MGZ01

Movimento Gratz con bussole  $\varnothing$  10x7 mm

5,85

10

*Mechanism-Gratz with bushes  $\varnothing$  10x7 mm*



## MGZ02

Movimento Gratz con perni  $\varnothing$  6x17 mm

7,80

10

*Mechanism-Gratz with pins  $\varnothing$  6x17 mm*



## MGZ03

Movimento Gratz con bussole  $\varnothing$  10x7 mm

11,70

10

*Mechanism-Gratz with bushes  $\varnothing$  10x7 mm*



## MGZ04

Movimento Gratz con perni  $\varnothing$  6x17 mm

12,35

10

*Mechanism-Gratz with pins  $\varnothing$  6x17 mm*



## FEFG01M\_L\_

Ferro fisso girevole con esagono con filetto M8/10/12

L	€
70	8,40
80	8,65
90	8,90
100	9,60
110	10,60
130	11,50

10

*Square spindle with threaded roller M8, M10, M12*

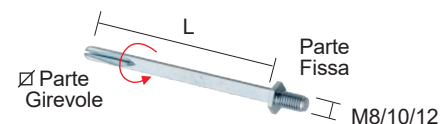

## FEFG02L\_

Ferro fisso girevole con piastrina di fissaggio con quadro 8 mm

L	€
70	8,40
80	8,65
90	8,90
100	9,60
110	10,60
130	11,50

10

*Square spindle with fixing base with mm 8 square spindle*

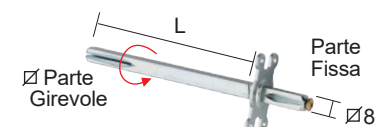

## FEE01L\_

Ferro quadro 8 mm ad espansione con dado

L	€
65	3,90
80	4,70

10

*Expansion square 8 mm spindle with nut*





# kts SECURITY DOORS



CODICE e DESCRIZIONE  
CODE and DESCRIPTION

FINITURE  
FINISHINGS

€

PCS/BOX

### SETBL01A

- Set per porta blindata composto da:
- Maniglia ORIONE ambidestra su rosetta  $\varnothing$  45 mm
  - Limitatore FARFALLA su rosetta  $\varnothing$  45 mm
    - Pomolo GLOBE  $\varnothing$  67 mm
  - Spioncino  $\varnothing$  16 mm - da 50 a 90 mm

OLV	76,50	1
BRG	83,20	1
CHS	77,30	1
CHL	82,80	1
PVD	112,60	1

LINEA ECO

- Set for security door:
- Reversible half handle with rose  $\varnothing$  45 mm
  - Little knob for opening limiting device with rose  $\varnothing$  45 mm
    - $\varnothing$  67 mm knob
  - $\varnothing$  16 mm door viewer, door tickness 50~90 mm



CODICE e DESCRIZIONE  
CODE and DESCRIPTION

FINITURE  
FINISHINGS

€

PCS/BOX

### SETBL04A

- Set per porta blindata composto da:
- Maniglia QUBE 2 ambidestra su rosetta 45x45 mm
  - Limitatore quadro su rosetta 45x45 mm
  - Pomolo FLASH 55x55 mm su rosetta 45x45 mm
  - Spioncino 30x30 mm - da 50 a 120 mm

CHS	87,50	1
CHL	94,50	1

LINEA ECO Q

- Set for security door:
- Reversible half handle with rose 45x45 mm
  - Little knob for opening limiting device with rose 45x45 mm
    - 55x55 mm knob
  - $\varnothing$  30x30 mm door viewer, door tickness 50~120 mm



CODICE e DESCRIZIONE CODE and DESCRIPTION	FINITURE FINISHINGS	€	PCS/BOX
<b>SETBL02A</b>			
Set per porta blindata composto da:	OLV	91,50	1
- Maniglia OLIVER ambidestra su rosetta ø 50 mm	BRG	98,20	1
- Limitatore a farfalla su rosetta ø 50 mm	CHS	92,30	1
- Pomolo NOVA ø 63 mm su rosetta ø 50 mm	PVD	127,60	1
- Spioncino ø 16 mm - da 50 a 90 mm			

**LINEA CLASSIC**

Set for security door:  
 - Reversible half handle with rose ø 50 mm  
 - Little knob for opening limiting device with rose ø 50 mm  
 - ø 63 mm knob  
 - ø 16 mm door viewer, door tickness 50~90 mm



<b>SETBL02B</b>				
	Set per porta blindata composto da:	OLV	57,20	1
	- Anello con defender ø 46 mm	BRG	58,80	1
	- Rosetta tonda con codolo farfalla	CHS	58,40	1
		PVD	74,20	1

Set for security door:  
 - Round escutcheon with armoured protection ø 46 mm  
 - Round escutcheon with little knob for cylinder



<b>SETBL02C</b>				
	Set per porta blindata composto da:	OLV	52,50	1
	- Anello con defender ø 46 mm	BRG	53,80	1
	- Rosetta tonda con foro cilindro	CHS	53,40	1
		PVD	69,20	1

Set for security door:  
 - Round escutcheon with armoured protection ø 46 mm  
 - Round escutcheon with cylinder hole



<b>SETBL02D</b>				
	Rosetta tonda per tastiera elettronica	OLV	24,90	1
		BRG	27,00	1
		CHS	25,80	1
		PVD	33,30	1

Round escutcheon or electronic key



CODICE e DESCRIZIONE CODE and DESCRIPTION	FINITURE FINISHINGS	€	PCS/BOX
----------------------------------------------	------------------------	---	---------

### SETBL03A

- Set per porta blindata composto da:
- Maniglia TECNO ambidestra su rosetta 55x55 mm
  - Limitatore quadro su rosetta 55x55 mm
  - Pomolo FLASH 65X65 mm su rosetta 55x55 mm
  - Spioncino 30x30 mm - da 50 a 120 mm

CHS 107,50 1

**LINEA MODERN**

- Set for security door:
- Reversible half handle with rose 55x55 mm
  - Little knob for opening limiting device with rose 55x55 mm
  - 65x65 mm knob
  - ø 30x30 mm door viewer, door tickness 50~120 mm

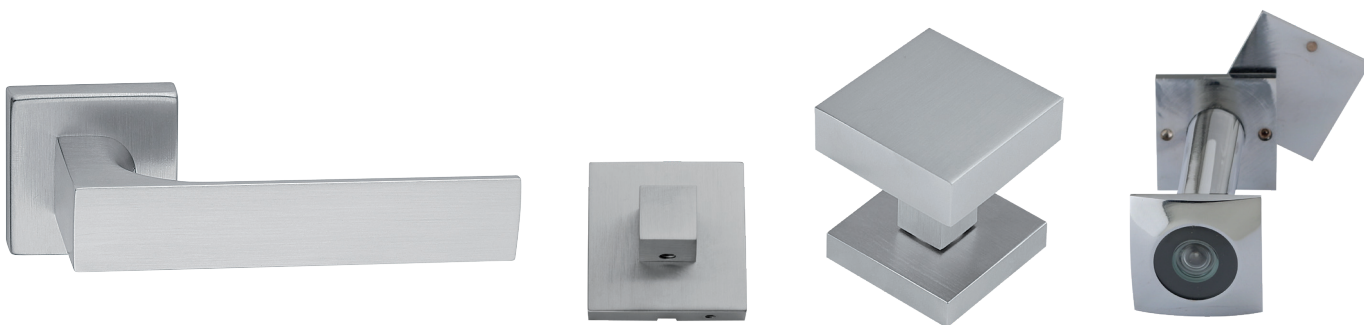

### SETBL03B

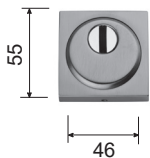

- Set per porta blindata composto da:
- Rosetta quadra con defender ø 46 mm
  - Rosetta quadra con codolo farfalla

CHS 62,40 1

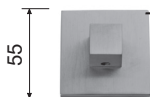

- Set for security door:
- Square escutcheon with armoured protection ø 46 mm
  - Square escutcheon with little knob for cylinder



### SETBL03C

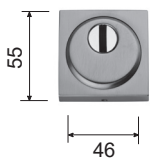

- Set per porta blindata composto da:
- Rosetta quadra con defender ø 46 mm
  - Rosetta quadra con foro cilindro

CHS 57,40 1

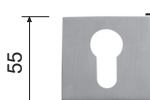

- Set for security door:
- Square escutcheon with armoured protection ø 46 mm
  - Square escutcheon with cylinder hole



### SETBL03D

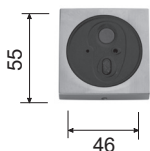

Rosetta quadra per tastiera elettronica

Square escutcheon for electronic key

CHS 27,80 1



	CODICE e DESCRIZIONE CODE and DESCRIPTION	FINITURE FINISHINGS	€	PCS/BOX	
<b>MB01FVV</b>					
	Mostrina foro $\varnothing$ 46/50 mm per defender	OLV	8,60	10	
	<i>Escutcheon with <math>\varnothing</math> 46/50 mm hole for armoured protection</i>	BRG	9,65	10	
		CHS	9,20	10	
		CHL	9,20	10	
		PVD	15,40	10	
<b>MB02FVV</b>					
	Mostrina foro doppia mappa	OLV	8,60	10	
	<i>Escutcheon with double bit key hole</i>	BRG	9,65	10	
		CHS	9,20	10	
		CHL	9,20	10	
		PVD	15,40	10	
<b>MB03FVV</b>					
	Mostrina foro cilindro	OLV	8,60	10	
	<i>Escutcheon with cylinder hole</i>	BRG	9,65	10	
		CHS	9,20	10	
		CHL	9,20	10	
		PVD	15,40	10	
<b>MB04FVV</b>					
	Mostrina foro $\varnothing$ 10,3 mm per codolo farfalla	OLV	8,60	10	
	<i>Escutcheon with <math>\varnothing</math> 10,3 mm hole for little knob</i>	BRG	9,65	10	
		CHS	9,20	10	
		CHL	9,20	10	
		PVD	15,40	10	

	CODICE e DESCRIZIONE CODE and DESCRIPTION	FINITURE FINISHINGS	€	PCS/BOX	
<b>MB01</b>					
	Mostrina foro $\varnothing$ 46/50 mm per defender	OLV	8,80	10	
	<i>Escutcheon with <math>\varnothing</math> 46/50 mm hole for armoured protection</i>	BRG	9,75	10	
		CHS	9,30	10	
		CHL	9,30	10	
		PVD	15,50	10	
		F1	6,30	10	
		F4	6,30	10	
<b>MB02</b>					
	Mostrina foro doppia mappa	OLV	8,80	10	
	<i>Escutcheon with double bit key hole</i>	BRG	9,75	10	
		CHS	9,30	10	
		CHL	9,30	10	
		PVD	15,50	10	
		F1	6,30	10	
		F4	6,30	10	
<b>MB03</b>					
	Mostrina foro cilindro	OLV	8,80	10	
	<i>Escutcheon with cylinder hole</i>	BRG	9,75	10	
		CHS	9,30	10	
		CHL	9,30	10	
		PVD	15,50	10	
		F1	6,30	10	
		F4	6,30	10	
<b>MB04</b>					
	Mostrina foro $\varnothing$ 10,3 mm per codolo farfalla	OLV	8,80	10	
	<i>Escutcheon with <math>\varnothing</math> 10,3 mm hole for little knob</i>	BRG	9,75	10	
		CHS	9,30	10	
		CHL	9,30	10	
		PVD	15,50	10	
		F1	6,30	10	
		F4	6,30	10	

CODICE e DESCRIZIONE CODE and DESCRIPTION	FINITURE FINISHINGS	€	PCS/BOX
<b>MBQ01</b>			
Mostrina foro $\varnothing$ 46/50 mm per defender	CHS	13,95	10
	CHL	14,95	10
	NEO	16,00	10

*Escutcheon  
with  $\varnothing$  46/50 mm  
hole for armoured  
protection*

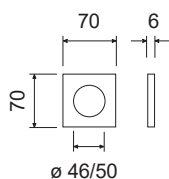

<b>MBQ03</b>			
Mostrina foro cilindro	CHS	13,95	10
	CHL	14,95	10
	NEO	16,00	10

*Escutcheon with  
cylinder hole*

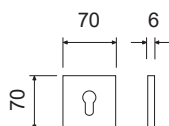

<b>MBQ04</b>			
Mostrina foro $\varnothing$ 10,3 mm per codolo farfalla	CHS	13,95	10
	CHL	14,95	10
	NEO	16,00	10

*Escutcheon with  $\varnothing$  10,3 mm  
hole for little knob*

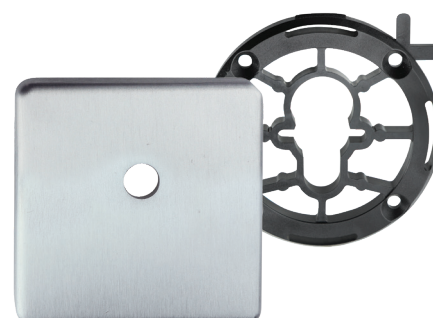
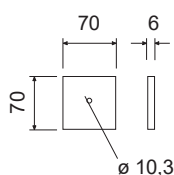

CODICE e DESCRIZIONE CODE and DESCRIPTION		FINITURE FINISHINGS	€	PCS/BOX	
<b>MBL01</b>					
<p>Placca foro maniglia e foro <math>\varnothing</math> 46/50 mm per defender</p> <p><i>Plate for handle with <math>\varnothing</math> 46/50 mm hole for armoured protection</i></p>	OLV	19,80	10		
	BRG	22,40	10		
	CHS	21,60	10		
	CHL	21,60	10		
	PVD	26,70	10		
	F1	12,60	10		
	F4	12,60	10		
<b>MBL02</b>					
<p>Placca foro maniglia e foro doppia mappa</p> <p><i>Plate for handle with double bit key hole</i></p>	OLV	19,80	10		
	BRG	22,40	10		
	CHS	21,60	10		
	CHL	21,60	10		
	PVD	26,70	10		
	F1	12,60	10		
	F4	12,60	10		
<b>MBL03</b>					
<p>Placca foro maniglia e foro cilindro</p> <p><i>Plate for handle with cylinder hole</i></p>	OLV	19,80	10		
	BRG	22,40	10		
	CHS	21,60	10		
	CHL	21,60	10		
	PVD	26,70	10		
	F1	12,60	10		
	F4	12,60	10		
<b>MBL04</b>					
<p>Placca foro maniglia e foro <math>\varnothing</math> 10,3 mm per codolo a farfalla</p> <p><i>Plate for handle with <math>\varnothing</math> 10,3 mm hole for little knob</i></p>	OLV	19,80	10		
	BRG	22,40	10		
	CHS	21,60	10		
	CHL	21,60	10		
	PVD	26,70	10		
	F1	12,60	10		
	F4	12,60	10		



CODICE e DESCRIZIONE  
CODE and DESCRIPTION

FINITURE  
FINISHINGS

€

PCS/BOX

## SPCBL01A

Defender ø 50 mm  
con bocchetta antistrappo

CHS  
PVD

33,60  
38,60

5  
5

*Armoured protection ø 50 mm  
with tear resistant escutcheon*

CODE	DEFENDER			ANTISCHOCK	
	Ø	INT.	HD	HA	K
13	50	38	15	13	8
18	50	38	18	18	8
22	50	38	22	22	8
27	50	38	25	27	4

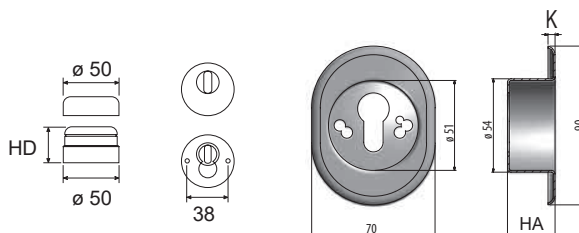

## SPCBL01B

Defender ø 50 mm  
con mostrina

OLV  
BRG  
CHS  
CHL  
PVD  
F1  
F4

27,70  
30,40  
29,50  
29,50  
36,00  
23,00  
23,00

8  
8  
8  
8  
8  
8  
8

*Armoured protection ø 50 mm  
with escutcheon*

CODE	DEFENDER		
	Ø	INT.	HD
15	50	38	15
18	50	38	18
22	50	38	22
25	50	38	25

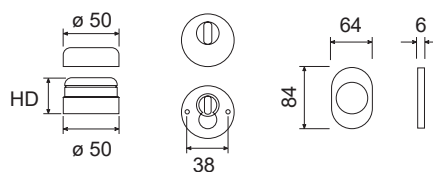

## SPCBL02A

Defender ø 46 mm  
con bocchetta antistrappo

CHS  
PVD

33,60  
38,60

5  
5

*Armoured protection ø 46 mm  
with tear resistant escutcheon*

CODE	DEFENDER			ANTISCHOCK	
	Ø	INT.	HD	HA	K
13	46	38	15	13	8
18	46	38	18	18	8
22	46	38	22	22	4
27	46	38	25	27	4

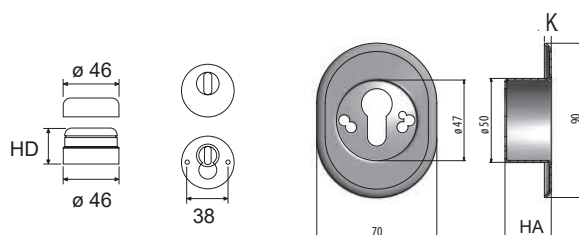

## SPCBL02B

Defender ø 46 mm  
con mostrina

OLV  
BRG  
CHS  
CHL  
PVD  
F1  
F4

27,70  
30,40  
29,50  
29,50  
36,00  
23,00  
23,00

8  
8  
8  
8  
8  
8  
8

*Armoured protection ø 46 mm  
with escutcheon*

CODE	DEFENDER		
	Ø	INT.	HD
15	46	38	15
18	46	38	18
22	46	38	22
25	46	38	25

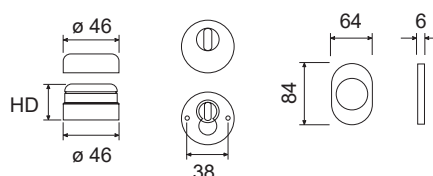

CODICE e DESCRIZIONE  
CODE and DESCRIPTION

FINITURE  
FINISHINGS

€

PCS/BOX

## SPCBL02D

Defender ø 46 mm  
con mostrina

CHS	40,50	8
CHL	42,50	8
NEO	45,00	8

Armoured protection ø 46 mm  
with escutcheon

CODE	DEFENDER		
	Ø	INT.	HD
22	46	38	22
25	46	38	25

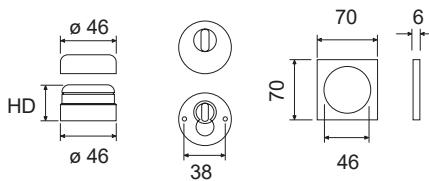

## SPCBL01D

Defender ø 50 mm  
con mostrina

CHS	40,50	8
CHL	42,50	8
NEO	45,00	8

Armoured protection ø 50 mm  
with escutcheon

CODE	DEFENDER		
	Ø	INT.	HD
15	50	38	15
18	50	38	18
22	50	38	22
25	50	38	25

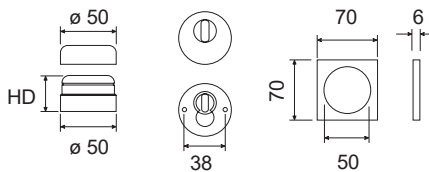

## SPCBL02C

Defender ø 46 mm  
con mostrina

OLV	29,70	8
BRG	32,40	8
CHS	31,50	8
CHL	31,50	8
PVD	38,00	8
NEO	35,00	8

Armoured protection ø 46 mm  
with escutcheon

CODE	DEFENDER		
	Ø	INT.	HD
22	46	38	22
25	46	38	25

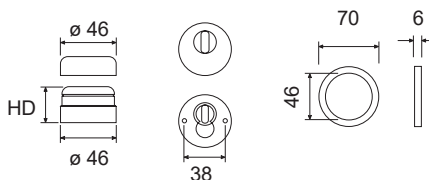

## SPCBL01C

Defender ø 50 mm  
con mostrina

OLV	29,70	8
BRG	32,40	8
CHS	31,50	8
CHL	31,50	8
PVD	38,00	8
NEO	35,00	8

Armoured protection ø 50 mm  
with escutcheon

CODE	DEFENDER		
	Ø	INT.	HD
15	50	38	15
18	50	38	18
22	50	38	22
25	50	38	25

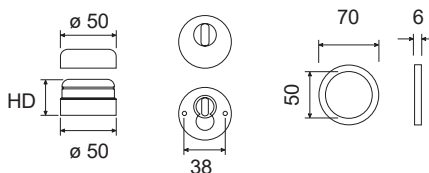

CODICE e DESCRIZIONE  
CODE and DESCRIPTION

FINITURE  
FINISHINGS

€

PCS/BOX

## 5014/50-80

Spioncino  $\varnothing$  14 mm - da 50 a 80 mm

OLV	10,80	10
BRU	10,60	10
CHS	10,40	10
CHL	11,80	10
OSV	10,60	10
NEO	12,00	

$\varnothing$  14 mm door viewer, door tickness 50~80 mm

## 5014/70-120

Spioncino  $\varnothing$  14 mm - da 70 a 120 mm

OLV	11,70	10
BRU	11,40	10
CHS	11,10	10
CHL	12,70	10

$\varnothing$  14 mm door viewer, door tickness 70~120 mm



## 7014/50-80

Spioncino 30x30 mm - da 50 a 80 mm

CHS	21,40	10
CHL	22,40	10

$\varnothing$  30x30 mm door viewer, door tickness 50~80 mm

## 7014/70-120

Spioncino 30x30 mm - da 70 a 120 mm

CHS	22,20	10
CHL	23,20	10

$\varnothing$  30x30 mm door viewer, door tickness 70~120 mm



# Visore digitale

## Digital door viewer

CODICE e DESCRIZIONE CODE and DESCRIPTION	FINITURE FINISHINGS	€	PCS/BOX
<b>DDW02</b>			
Visore digitale ribassato con schermo LCD da 3,5 pollici spessore porta da 40 a 110 mm alimentazione: 4 batterie (non include)	ORO	163,50	1
	ARG	163,50	1

*Digital door viewer LCD screen 3,5 pollici  
door ticknees 40~110 mm  
power source: 4 batteries*



<b>DDW03</b>			
Visore digitale ribassato con schermo LCD da 3,5 pollici spessore porta da 40 a 110 mm alimentazione: 4 batterie (non include)	ORO	142,50	1
	ARG	142,50	1

*Digital door viewer LCD screen 3,5 pollici  
door ticknees 40~110 mm  
power source: 4 batteries*



**kt** SLIDING DOORS



# Accessori per porte scorrevoli

## Accessories for sliding doors

CODICE e DESCRIZIONE CODE and DESCRIPTION		FINITURE FINISHINGS	€	PCS/BOX	
<b>KITPST01B</b>					
Kit porte scorrevoli		OLV	40,25	4	
<i>Sliding door kit</i>		BRG	44,95	4	
		BRY	48,95	4	
		CHS	42,80	4	
		CHL	42,80	4	
		PVD	65,10	4	
<b>KITPST03B</b>					
Kit porte scorrevoli foro chiave		OLV	25,40	5	
<i>Sliding door kit</i>		BRG	27,90	5	
		BRY	30,85	5	
		CHS	27,00	5	
		CHL	27,00	5	
		PVD	41,00	5	
<b>KITPST04B</b>					
Kit porte scorrevoli foro cilindro		OLV	25,40	5	
<i>Sliding door kit</i>		BRG	27,90	5	
		BRY	30,85	5	
		CHS	27,00	5	
		CHL	27,00	5	
		PVD	41,00	5	
<b>KITPST05B</b>					
Kit porte scorrevoli senza foro		OLV	25,40	5	
<i>Sliding door kit</i>		BRG	27,90	5	
		BRY	30,85	5	
		CHS	27,00	5	
		CHL	27,00	5	
		PVD	41,00	5	

# Accessori per porte scorrevoli

## Accessories for sliding doors



CODICE e DESCRIZIONE CODE and DESCRIPTION	FINITURE FINISHINGS	€	PCS/BOX
<b>KITPSQ01B</b>			
Kit porte scorrevoli	CHS	46,20	4
	CHL	46,20	4
<i>Sliding door kit</i>	PVD	68,90	4

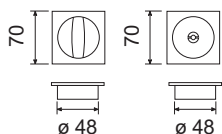

<b>KITPSQ03B</b>			
Kit porte scorrevoli foro chiave	CHS	29,00	5
	CHL	29,00	5
<i>Sliding door kit</i>	PVD	42,85	5

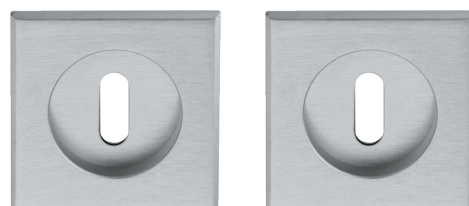
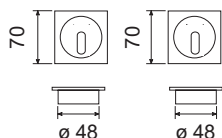

<b>KITPSQ04B</b>			
Kit porte scorrevoli foro cilindro	CHS	29,00	5
	CHL	29,00	5
<i>Sliding door kit</i>	PVD	42,85	5

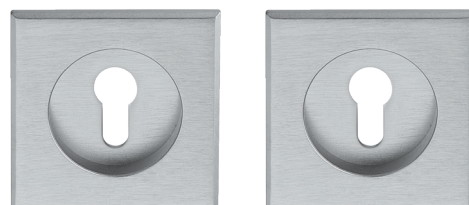
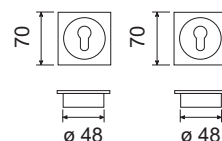

<b>KITPSQ05B</b>			
Kit porte scorrevoli senza foro	CHS	29,00	5
	CHL	29,00	5
<i>Sliding door kit</i>	PVD	42,85	5

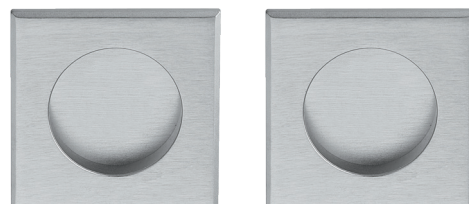
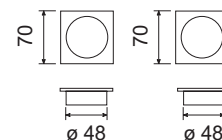

# Accessori per porte scorrevoli

## Accessories for sliding doors

	CODICE e DESCRIZIONE CODE and DESCRIPTION	FINITURE FINISHINGS	€	PCS/BOX	
<b>KITPST01</b>					
	Kit porte scorrevoli	OLV	28,75	6	
	<i>Sliding door kit</i>	BRG	33,95	6	
		BRY	34,95	6	
		CHS	30,60	6	
		CHL	30,60	6	
		PVD	46,50	6	
<b>KITPST02</b>					
	Kit porte scorrevoli	OLV	27,75	6	
	<i>Sliding door kit</i>	BRG	32,95	6	
		BRY	33,95	6	
		CHS	29,90	6	
		CHL	29,90	6	
		PVD	45,40	6	
<b>KITPST02W</b>					
	Kit porte scorrevoli libero/occupato	OLV	28,75	6	
	<i>Sliding door kit</i>	BRG	33,95	6	
		BRY	34,95	6	
		CHS	30,90	6	
		CHL	30,90	6	
		PVD	46,40	6	
<b>KITPLT01</b>					
	Kit porte a libro con doppio nottolino con pendente	OLV	41,00	6	
	<i>Sliding door kit</i>	BRG	44,20	6	
		BRY	46,20	6	
		CHS	42,80	6	
		CHL	43,80	6	
		NEO	47,80	6	



# Accessori per porte scorrevoli

## Accessories for sliding doors

	CODICE e DESCRIZIONE CODE and DESCRIPTION	FINITURE FINISHINGS	€	PCS/BOX	
<b>KITPST03</b>					
	Kit porte scorrevoli foro chiave	OLV	18,10	10	
		BRG	20,35	10	
	<i>Sliding door kit</i>	BRY	21,35	10	
		CHS	19,40	10	
		CHL	19,40	10	
		PVD	27,40	10	
<b>KITPST04</b>					
	Kit porte scorrevoli foro cilindro	OLV	18,10	10	
		BRG	20,35	10	
	<i>Sliding door kit</i>	BRY	21,35	10	
		CHS	19,40	10	
		CHL	19,40	10	
		PVD	27,40	10	
<b>KITPST05</b>					
	Kit porte scorrevoli senza foro	OLV	18,10	10	
		BRG	20,35	10	
	<i>Sliding door kit</i>	BRY	21,35	10	
		CHS	19,40	10	
		CHL	19,40	10	
		PVD	27,40	10	
<b>KITPST06</b>					
	Kit porte scorrevoli mezzaluna	OLV	22,65	10	
		BRG	25,45	10	
	<i>Sliding door kit</i>	BRY	26,45	10	
		CHS	24,25	10	
		CHL	24,25	10	
		PVD	34,25	10	

# Accessori per porte scorrevoli

## Accessories for sliding doors







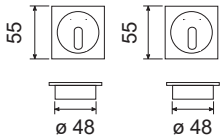

	CODICE e DESCRIZIONE CODE and DESCRIPTION	FINITURE FINISHINGS	€	PCS/BOX		
<b>KITPSQ01</b>						
	Kit porte scorrevoli	CHS	33,00	6		
	<i>Sliding door kit</i>	CHL	33,00	6		
<b>KITPSQ02</b>						
	Kit porte scorrevoli	CHS	32,00	6		
	<i>Sliding door kit</i>	CHL	32,00	6		
<b>KITPSQ02W</b>						
	Kit porte scorrevoli libero/occupato	CHS	33,00	6		
	<i>Sliding door kit</i>	CHL	33,00	6		
<b>KITPLQ01</b>						
	Kit porte a libro con doppio nottolino con pendente	CHS	46,80	6		
	<i>Sliding door kit</i>	CHL	47,80	6		
		NEO	51,80	6		

# Accessori per porte scorrevoli

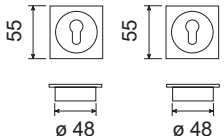
## Accessories for sliding doors

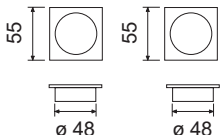
**kts**

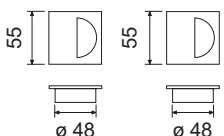
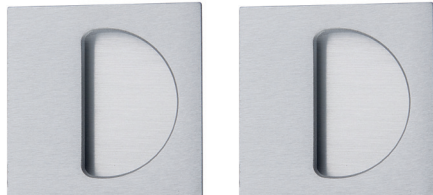
	CODICE e DESCRIZIONE CODE and DESCRIPTION	FINITURE FINISHINGS	€	PCS/BOX	
<b>KITPSQ03</b>					
	Kit porte scorrevoli foro chiave	CHS CHL	20,70 20,70	10 10	
	<i>Sliding door kit</i>				
					
<b>KITPSQ04</b>					
	Kit porte scorrevoli foro cilindro	CHS CHL	20,70 20,70	10 10	
	<i>Sliding door kit</i>				
					
<b>KITPSQ05</b>					
	Kit porte scorrevoli senza foro	CHS CHL	20,70 20,70	10 10	
	<i>Sliding door kit</i>				
					
<b>KITPSQ06</b>					
	Kit porte scorrevoli mezzaluna	CHS CHL	25,90 25,90	10 10	
	<i>Sliding door kit</i>				
					

# Accessori per porte scorrevoli

## Accessories for sliding doors

CODICE e DESCRIZIONE CODE and DESCRIPTION	FINITURE FINISHINGS	€	PCS/BOX	
<b>KITPS002</b>				
Kit porte scorrevoli con nottolino e virte emergenza	OLV	36,80	6	
<i>Sliding door kit</i>	BRG	37,00	6	
	BRY	38,00	6	
	CHS	39,20	6	
	CHL	39,20	6	
<b>KITPS003</b>				
Kit porte scorrevoli foro chiave	OLV	24,00	6	
<i>Sliding door kit</i>	BRG	27,00	6	
	BRY	28,00	6	
	CHS	30,00	6	
	CHL	30,00	6	
<b>KITPS005</b>				
Kit porte scorrevoli senza foro	OLV	24,00	6	
<i>Sliding door kit</i>	BRG	27,00	6	
	BRY	28,00	6	
	CHS	30,00	6	
	CHL	30,00	6	
<b>KITPS006</b>				
Kit porte scorrevoli senza foro push	OLV	31,20	6	
<i>Sliding door kit</i>	BRG	34,20	6	
	BRY	35,20	6	
	CHS	36,20	6	
	CHL	36,20	6	

# Accessori per porte scorrevoli

## Accessories for sliding doors



CODICE e DESCRIZIONE CODE and DESCRIPTION	FINITURE FINISHINGS	€	PCS/BOX	
<b>KITPSR02</b>				
Kit porte scorrevoli con nottolino e virte emergenza	CHS CHL	42,20 42,20	6 6	
<i>Sliding door kit</i>				
<b>KITPSR03</b>				
Kit porte scorrevoli foro chiave	CHS CHL	32,00 32,00	6 6	
<i>Sliding door kit</i>				
<b>KITPSR05</b>				
Kit porte scorrevoli senza foro	CHS CHL	32,00 32,00	6 6	
<i>Sliding door kit</i>				
<b>KITPSR06</b>				
Kit porte scorrevoli senza foro push	CHS CHL	39,20 39,20	6 6	
<i>Sliding door kit</i>				

# Accessori per porte scorrevoli

## Accessories for sliding doors

CODICE e DESCRIZIONE  
CODE and DESCRIPTION

FINITURE  
FINISHINGS

€

PCS/BOX

### SETPST01B

Set per porte scorrevoli

OLV

54,65

1

BRG

60,65

1

*Sliding door set*

BRY

65,65

1

CHS

59,50

1

CHL

59,50

1

PVD

79,50

1

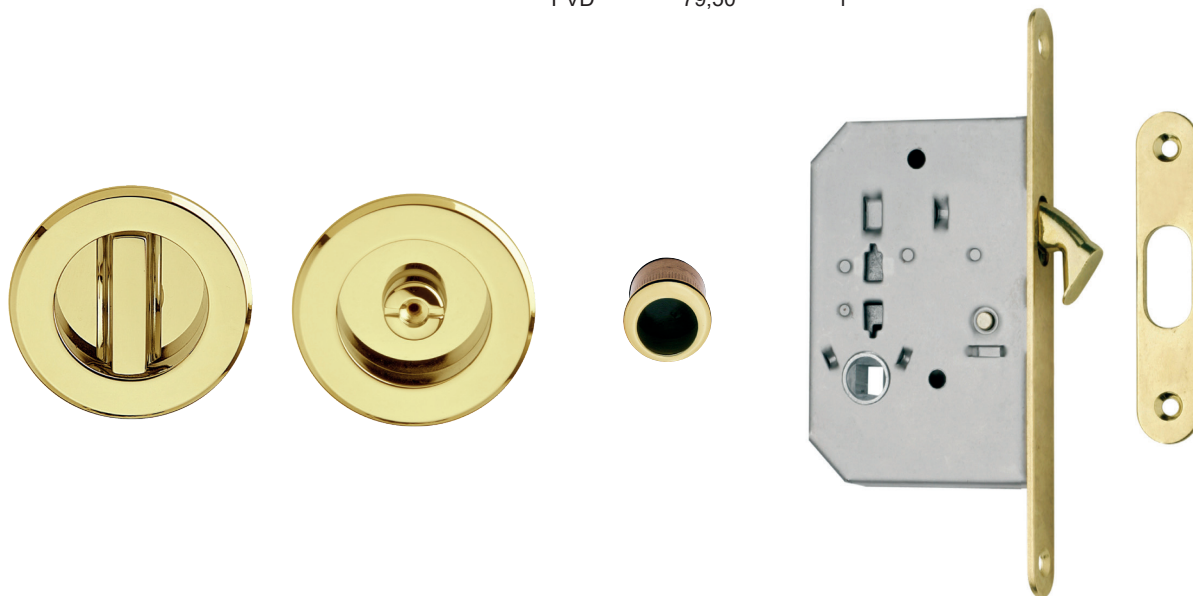

### SETPST03B

Set per porte scorrevoli

OLV

43,70

1

BRG

49,30

1

*Sliding door set*

BRY

52,55

1

CHS

48,20

1

CHL

48,20

1

PVD

59,30

1

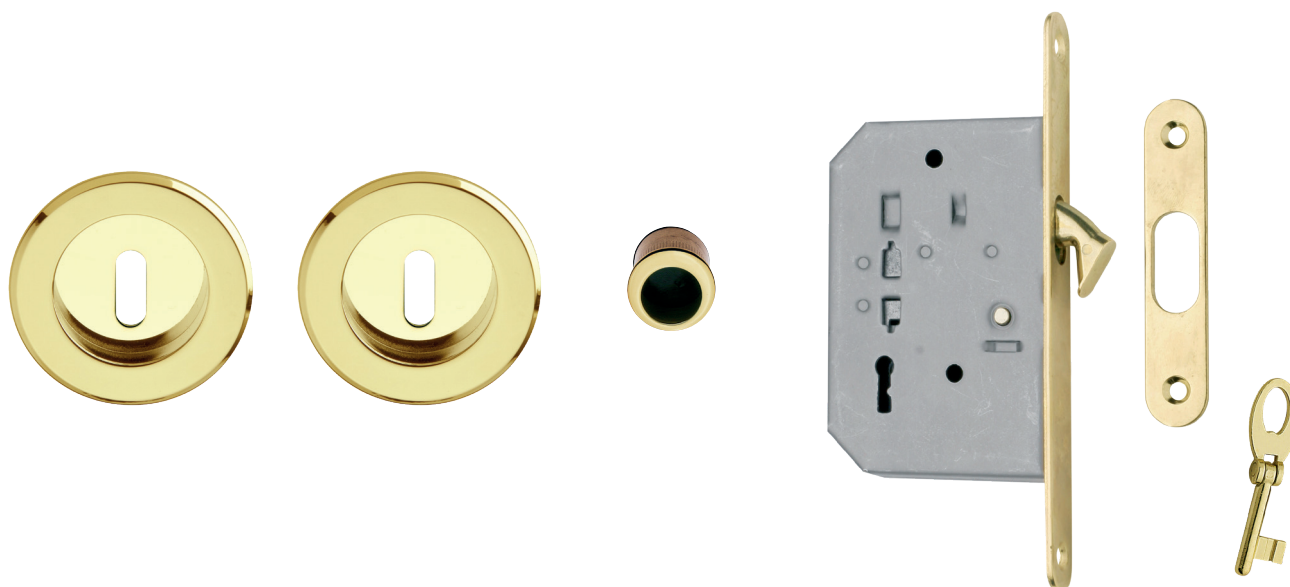

# Accessori per porte scorrevoli

## Accessories for sliding doors



CODICE e DESCRIZIONE CODE and DESCRIPTION	FINITURE FINISHINGS	€	PCS/BOX
<b>SETPSQ01B</b>			
Set per porte scorrevoli	CHS	63,20	1
	CHL	63,20	1
<i>Sliding door set</i>	PVD	85,40	1

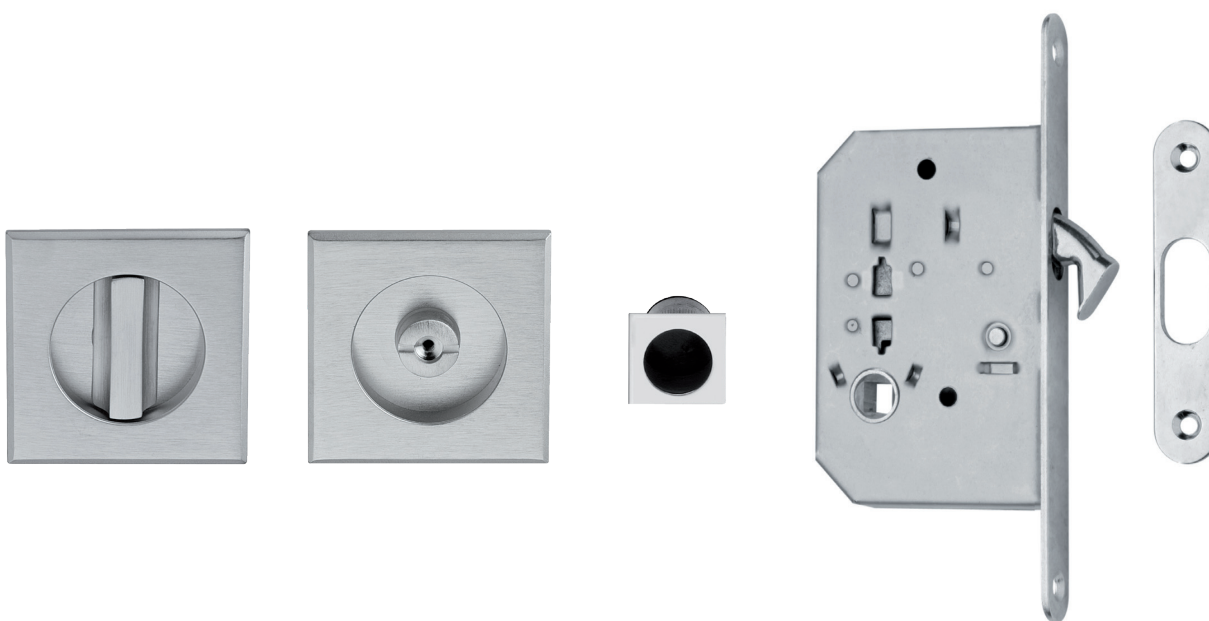

<b>SETPSQ03B</b>			
Set per porte scorrevoli	CHS	50,50	1
	CHL	50,50	1
<i>Sliding door set</i>	PVD	63,25	1

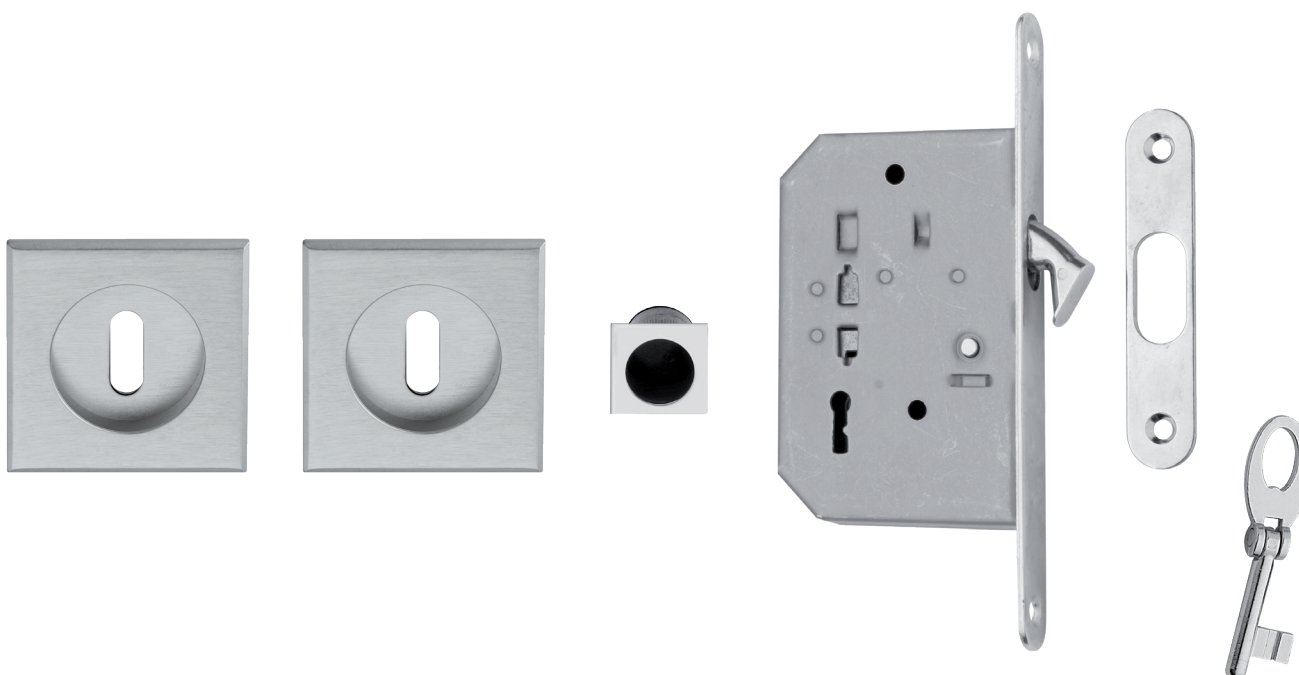

# Accessori per porte scorrevoli

## Accessories for sliding doors

CODICE e DESCRIZIONE CODE and DESCRIPTION	FINITURE FINISHINGS	€	PCS/BOX	
<b>SETPST01</b>				
Set per porte scorrevoli	OLV	43,15	1	
	BRG	50,53	1	
<i>Sliding door set</i>	BRY	51,65	1	
	CHS	47,30	1	
	CHL	47,30	1	
	PVD	60,90	1	
	BAO	54,00	1	
	NEO	53,00	1	

<b>SETPST02</b>				
Set per porte scorrevoli	OLV	42,15	1	
	OSV	55,00	1	
<i>Sliding door set</i>	BRG	49,35	1	
	BRY	50,65	1	
	CHS	46,60	1	
	CHL	46,60	1	
	PVD	59,90	1	
	BAO	53,00	1	
	NEO	52,00	1	
	ANT	55,00	1	

<b>SETPST03</b>				
Set per porte scorrevoli	OLV	36,40	1	
	BRG	41,75	1	
<i>Sliding door set</i>	BRY	43,05	1	
	CHS	40,60	1	
	CHL	40,60	1	
	PVD	51,70	1	
	BAO	45,00	1	
	NEO	44,00	1	
	ANT	47,00	1	



# Accessori per porte scorrevoli

## Accessories for sliding doors

**kts**

CODICE e DESCRIZIONE CODE and DESCRIPTION	FINITURE FINISHINGS	€	PCS/BOX
<b>SETPSQ01</b>			
Set per porte scorrevoli	CHS	50,00	1
	CHL	50,00	1
<i>Sliding door set</i>	BAO	56,00	1
	NEO	55,00	1

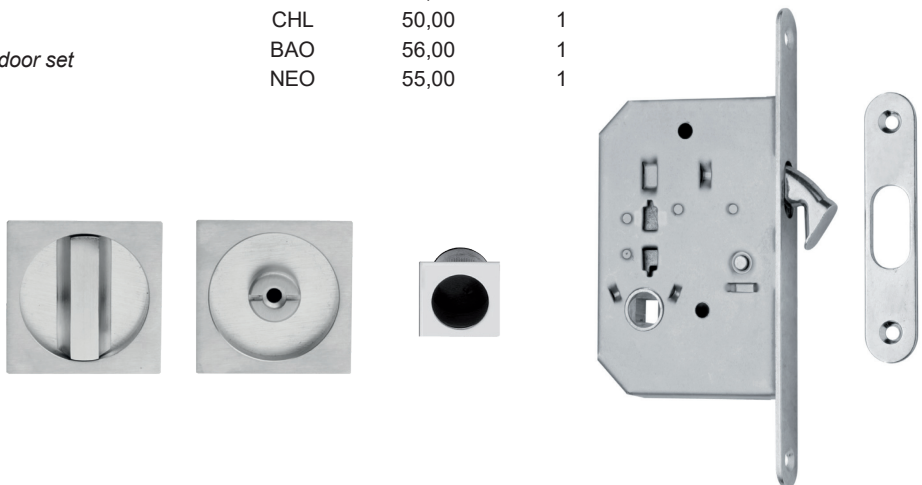

<b>SETPSQ02</b>			
Set per porte scorrevoli	OSV	57,00	1
	CHS	49,00	1
<i>Sliding door set</i>	CHL	49,00	1
	BAO	55,00	1
	NEO	54,00	1
	ANT	57,00	1



<b>SETPSQ03</b>			
Set per porte scorrevoli	CHS	42,20	1
	CHL	42,20	1
<i>Sliding door set</i>	BAO	47,00	1
	NEO	46,00	1
	ANT	49,00	1

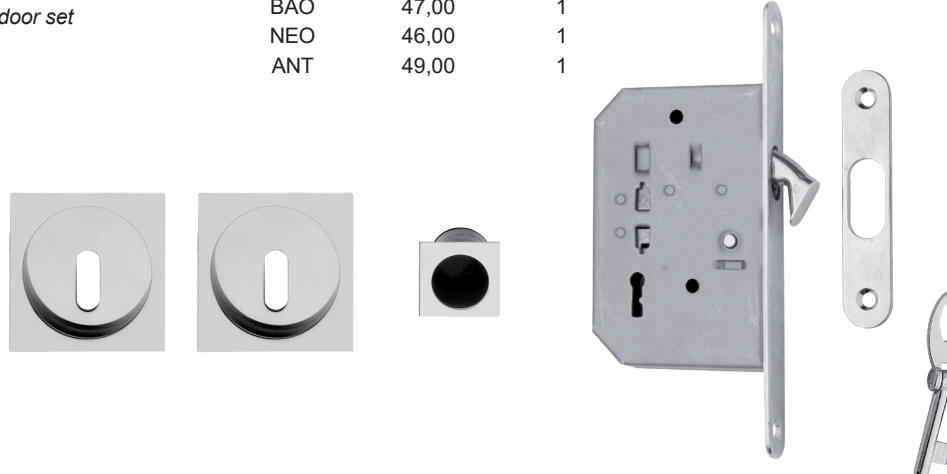

# Accessori per porte scorrevoli

## Accessories for sliding doors

CODICE e DESCRIZIONE  
CODE and DESCRIPTION

FINITURE  
FINISHINGS

€

PCS/BOX

### SETPSO02

Set per porte scorrevoli

OLV

51,20

1

BRG

53,40

1

*Sliding door set*

BRY

54,70

1

CHS

55,90

1

CHL

55,90

1

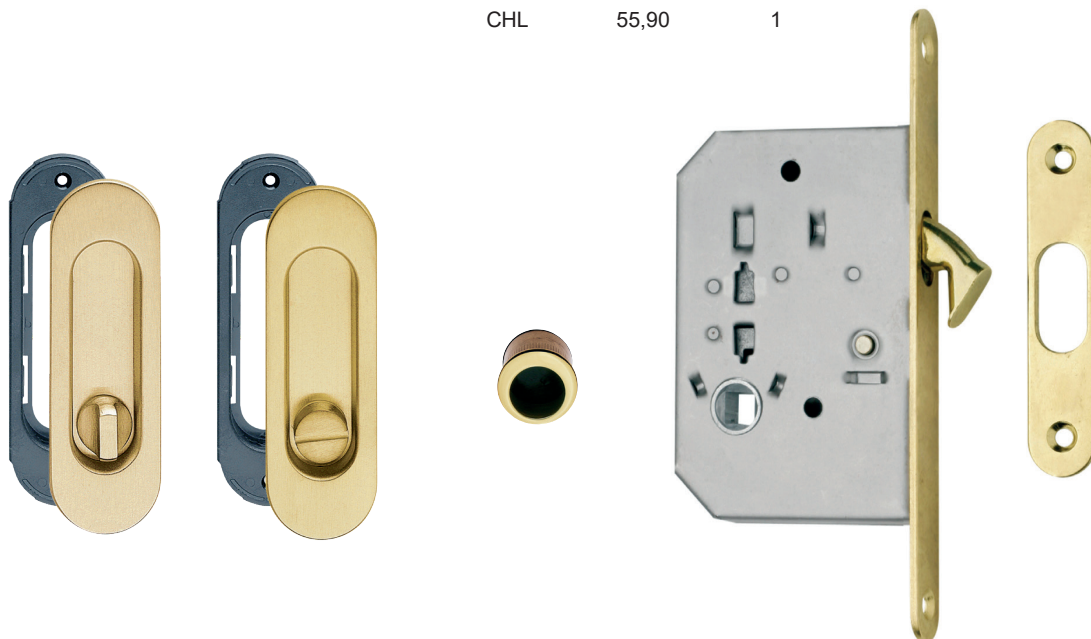

### SETPSO03

Set per porte scorrevoli

OLV

42,30

1

BRG

48,40

1

*Sliding door set*

BRY

49,70

1

CHS

51,20

1

CHL

51,20

1

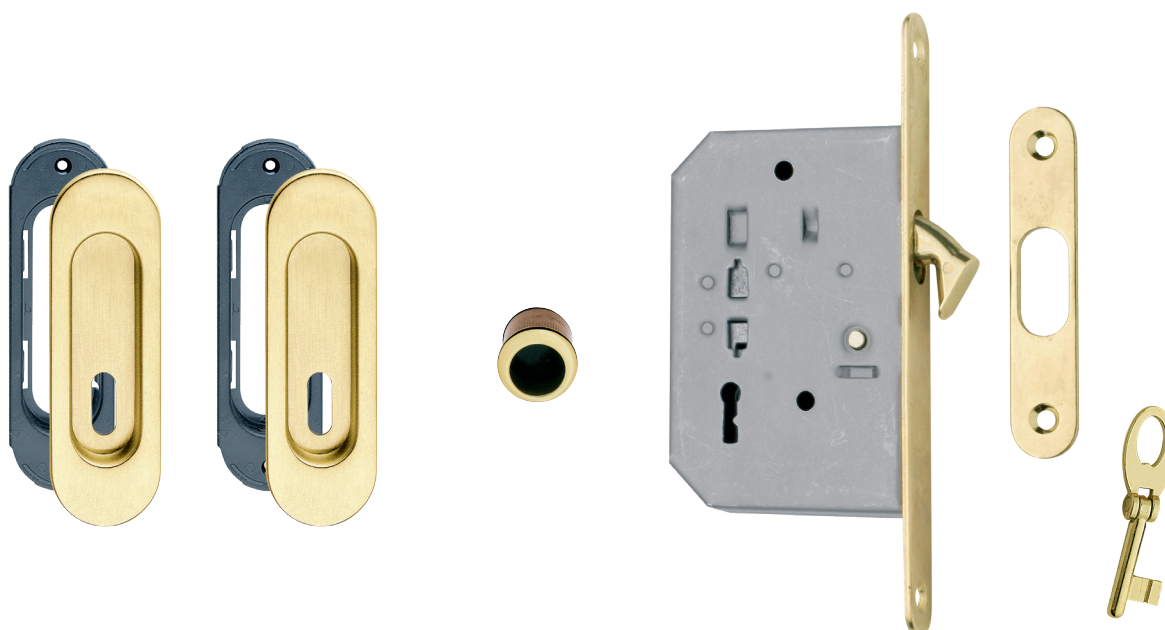

# Accessori per porte scorrevoli

## Accessories for sliding doors

CODICE e DESCRIZIONE CODE and DESCRIPTION	FINITURE FINISHINGS	€	PCS/BOX
<b>SETPSR02</b>			
Set per porte scorrevoli	CHS	59,20	1
	CHL	59,20	1
<i>Sliding door set</i>			

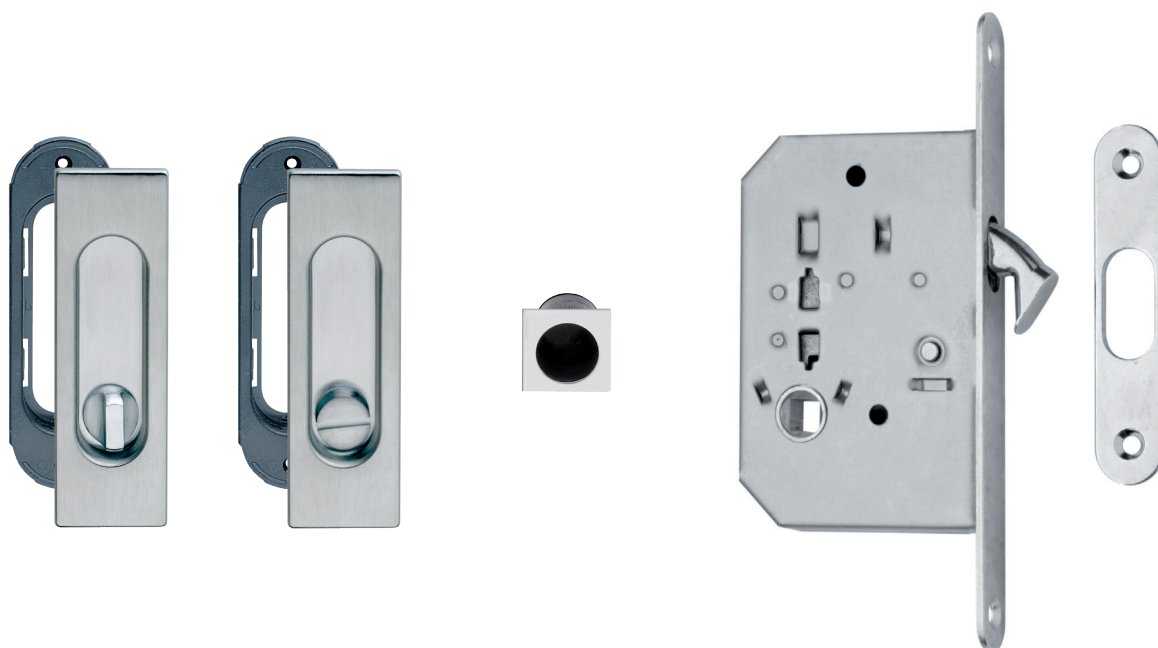

<b>SETPSR03</b>			
Set per porte scorrevoli	CHS	53,50	1
	CHL	53,50	1
<i>Sliding door set</i>			



# Accessori per porte scorrevoli

## Accessories for sliding doors

CODICE e DESCRIZIONE CODE and DESCRIPTION	FINITURE FINISHINGS	€	PCS/BOX
<b>TPSQ01</b>			
Trascinatore quadro	CHS	4,70	25
Square flush pull hole	CHL	4,70	25
	NEO	5,70	25

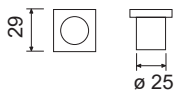

<b>TPST01</b>			
Trascinatore tondo	OLV	3,60	25
Round flush pull hole	BRG	4,90	25
	BRY	5,20	25
	CHS	4,40	25
	CHL	4,40	25
	NEO	5,40	25



<b>SPS01</b>			
Serratura per ferro $\varnothing$ 8 mm	OLV	10,80	6
Lock for 8x8 mm spindle	BRG	11,50	6
	BRY	11,50	6
	CHS	12,30	6
	CHL	12,30	6
	BAO	13,00	6
	NEO	12,50	6

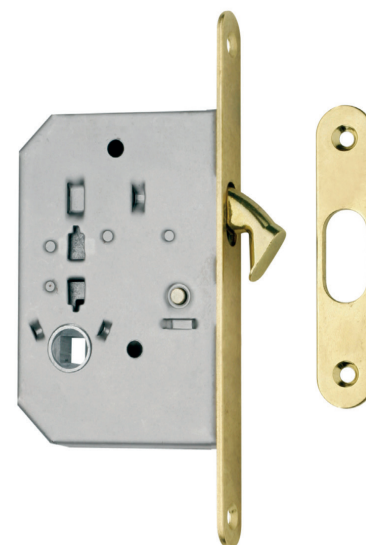
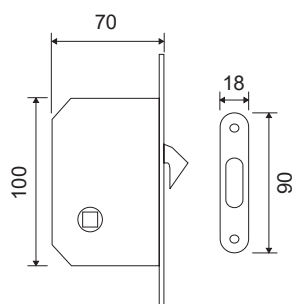

<b>SPS02</b>			
Serratura con chiave snodabile	OLV	14,70	6
Lock with Key	BRG	16,50	6
	BRY	16,50	6
	CHS	16,80	6
	CHL	16,80	6

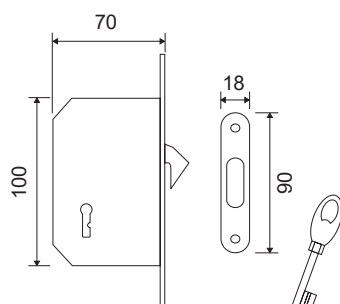

# Sistemi per scorrevoli

## Sliding door system



CODICE e DESCRIZIONE  
CODE and DESCRIPTION

€

PCS/BOX

### JL-25DLT

Kit porta scorrevole 80P  
completo di binario in alluminio MT. 1,90  
squadretta esclusa

50,90

1

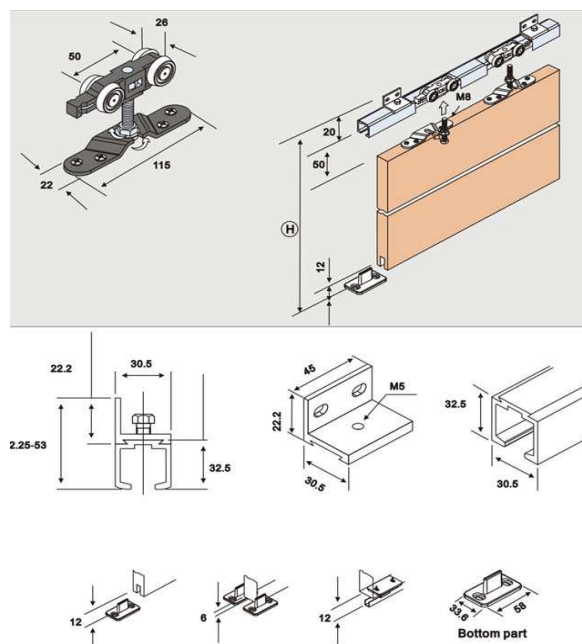

### JL-747

Kit porta scorrevole 110  
completo di binario in alluminio MT. 1,90  
con staffe a scomparsa porta filo  
squadretta esclusa

64,30

1

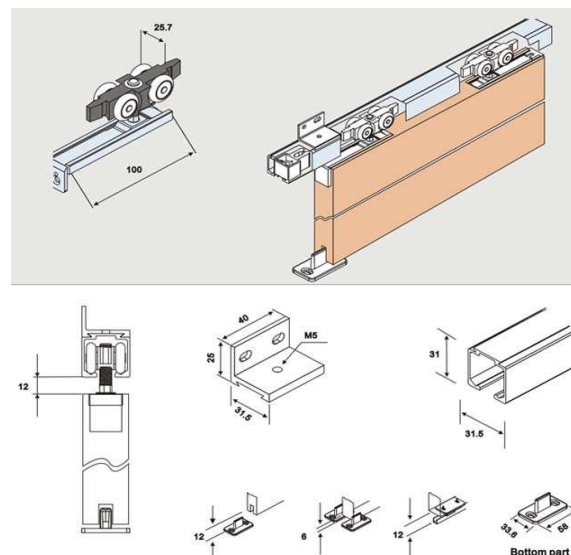
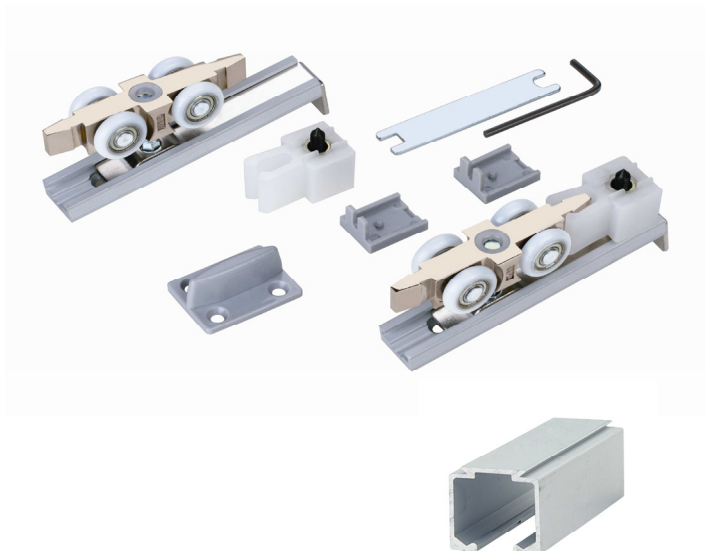

# Sistemi per scorrevoli

## Sliding door system



CODICE e DESCRIZIONE CODE and DESCRIPTION	FINITURE FINISHINGS	€	PCS/BOX
<b>JL-4000-40</b>			
Kit porta scorrevole portata 40 Kg completo di binario in alluminio MT. 1,90 squadretta esclusa		47,60	1

Technical drawings for JL-4000-40 showing dimensions: 28, 20, 64, 20, 20, 50, H, 12, 48.25-49.58, 25, 28.7-29.75, 28, 25, 40, M6, 29.5, 30.5, 12, 6, 12, 30.5, 30.5, Bottom part.

<b>JL-4000-80</b>			
Kit porta scorrevole portata 80 Kg completo di binario in alluminio MT. 1,90 squadretta esclusa		56,90	1

Technical drawings for JL-4000-80 showing dimensions: 28, 20, 64, 20, 20, 50, H, 12, 48.25-49.58, 25, 28.7-29.75, 28, 25, 40, M6, 29.5, 30.5, 12, 6, 12, 30.5, 30.5, Bottom part.

# Sistemi per scorrevoli

## Sliding door system



CODICE e DESCRIZIONE CODE and DESCRIPTION	FINITURE FINISHINGS	€	PCS/BOX
<b>JL-160</b>			
Kit porta scorrevole portata 120 Kg completo di binario in alluminio MT. 1,90 squadretta esclusa		67,60	1

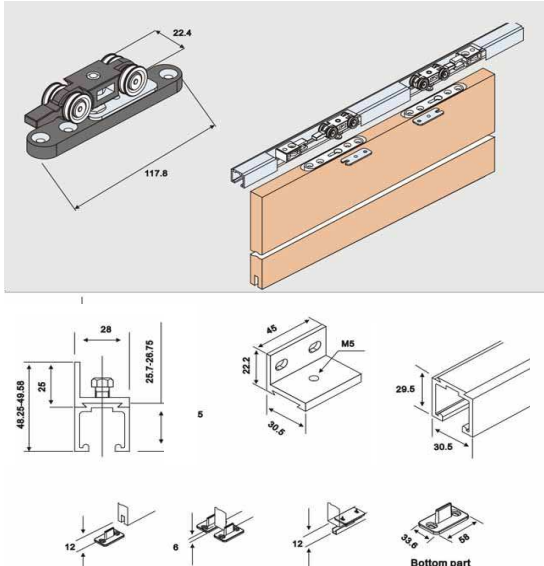

<b>JL-4500</b>			
Kit porta scorrevole 100 completo di binario in alluminio MT. 1,90 con staffe a scomparsa porta filo squadretta esclusa		72,70	1

# Sistemi per scorrevoli

## Sliding door system

**kts**

CODICE e DESCRIZIONE CODE and DESCRIPTION	FINITURE FINISHINGS	€	PCS/BOX
<b>JL-747-48</b>			
Set carrelli 80 staffe a scomparsa con accessori porta a filo binario e squadretta esclusi		29,30	1

<b>R-160</b>			
Binario in alluminio per scorrevoli L=MT 5,8 PORTATA 120 Kg		124,80	1

<b>R-160S</b>			
Squadretta per fissaggio laterale binario per scorrevoli		3,50	1



# Sistemi per scorrevoli

## Sliding door system



CODICE e DESCRIZIONE  
CODE and DESCRIPTION

FINITURE  
FINISHINGS

PCS/BOX

JL-LZ

Supporto radrizzante  
con regolazione  
centrale e laterale

17,90

1

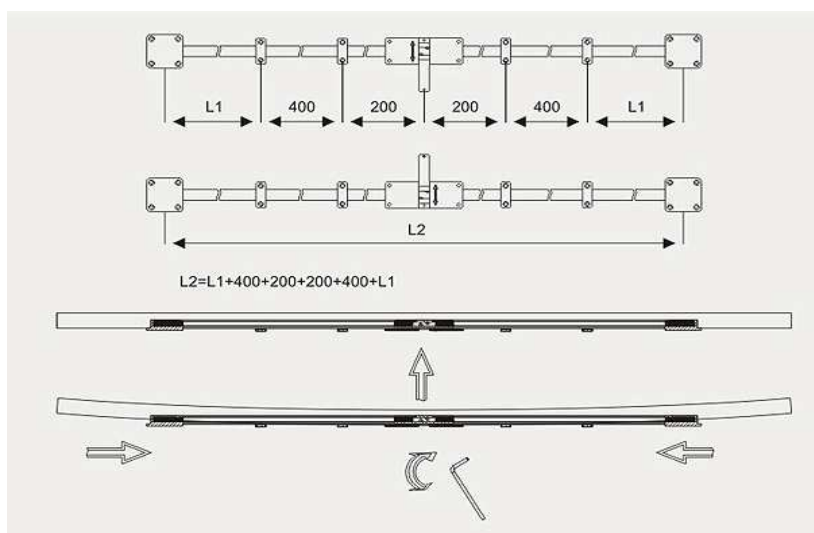
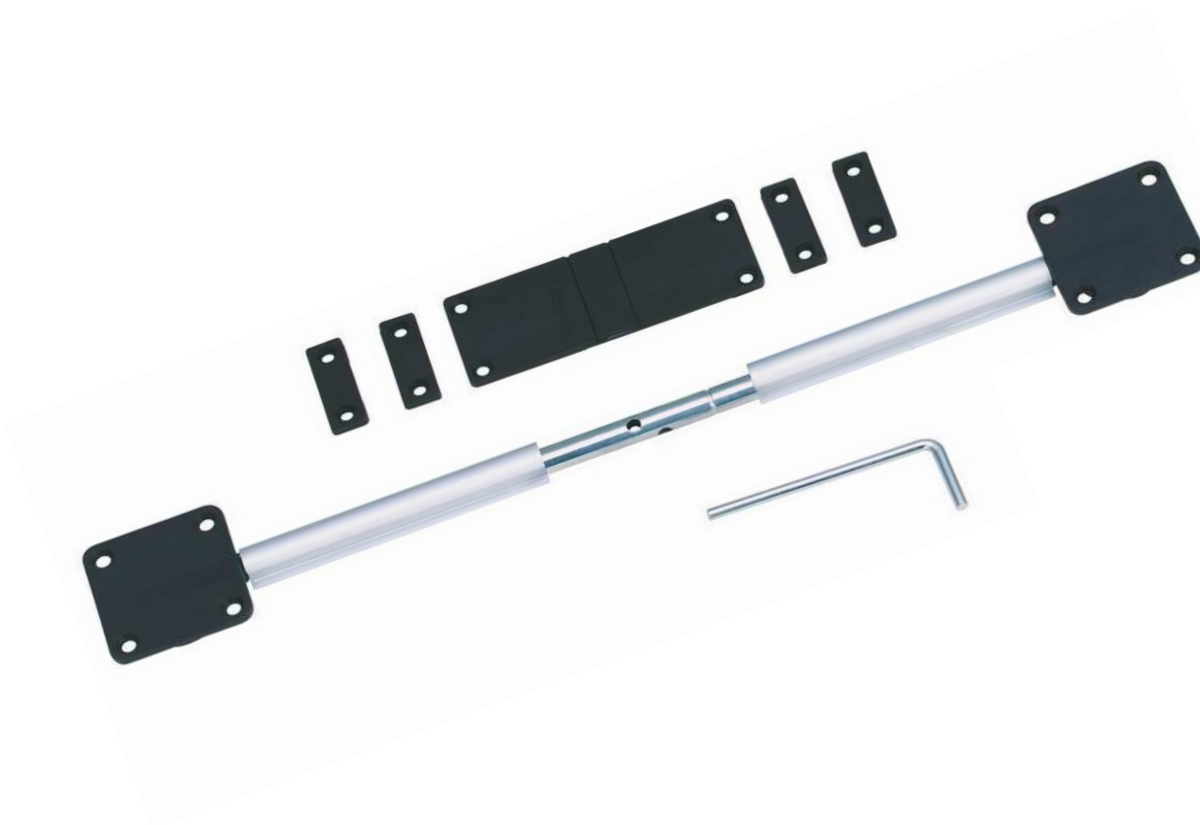



CODICE e DESCRIZIONE  
CODE and DESCRIPTION

FINITURE  
FINISHINGS

€

PCS/BOX

## 7023

Chiudiporta  
con 2 valvole di regolazione:  
velocità e scrocco

Door closer

ARG  
NEO  
BAO  
BR

1  
1  
1  
1

CODE	DIMENSIONI					PORTATA (Kg)	LARGHEZZA	FUNZIONE	€
	A	B	C	D	E				
7023AD	180	41,5	62,5	19	165	40-65	≤ 950	con fermo	53,60
7023AW	180	41,5	62,5	19	165	40-65	≤ 950	senza fermo	51,20

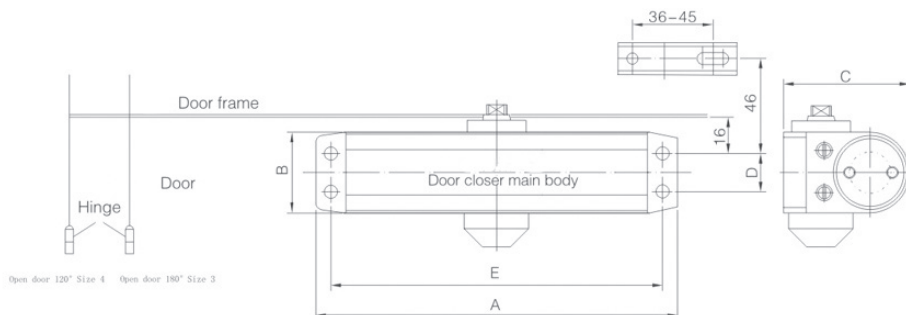

## 5034

Chiudiporta  
con 2 valvole di regolazione:  
velocità e scrocco

Door closer

ARG  
NEO

1  
1

CODE	DIMENSIONI					PORTATA (Kg)	LARGHEZZA	FUNZIONE	€
	A	B	C	D	E				
5034AD	206	44,5	68	19	188	60-85	≤ 1050	con fermo	67,20

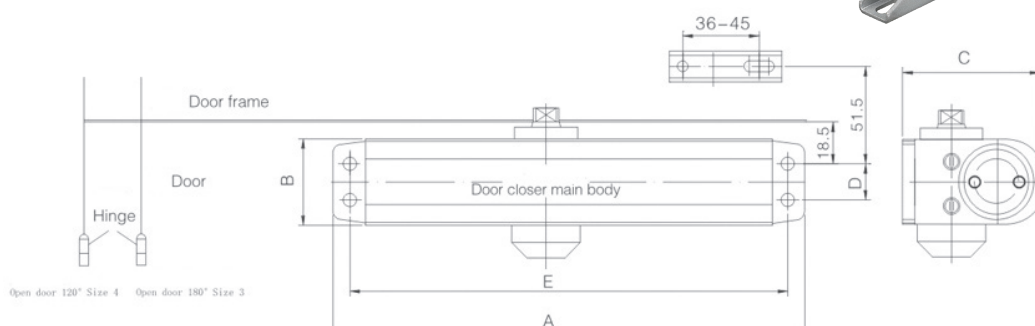

CODICE e DESCRIZIONE  
CODE and DESCRIPTION

FINITURE  
FINISHINGS

PCS/BOX

1134

Chiudiporta  
con 2 valvole di regolazione:  
velocità e scrocco

ARG  
NEO

1  
1

Door closer

CODE	DIMENSIONI						PORTATA (Kg)	LARGHEZZA	FUNZIONE	€
	A	B	C	D	E	F				
1134AD	207	60	38,5	43	50	14	60-85	≤ 1050	con braccio a gomito con fermo	160,70



CODE	DIMENSIONI						PORTATA (Kg)	LARGHEZZA	FUNZIONE	€
	A	B	C	D	E	F				
1134H	207	60	38,5	43	50	14	60-85	≤ 1050	con braccio a slitta con fermo	153,15

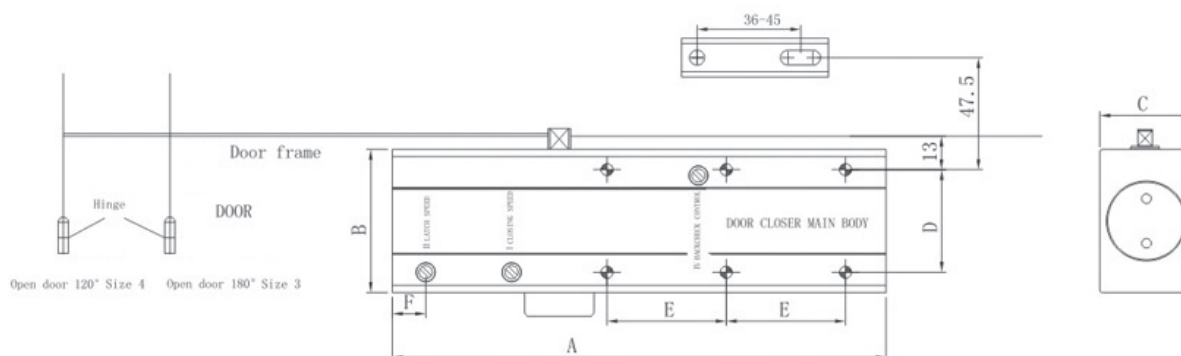
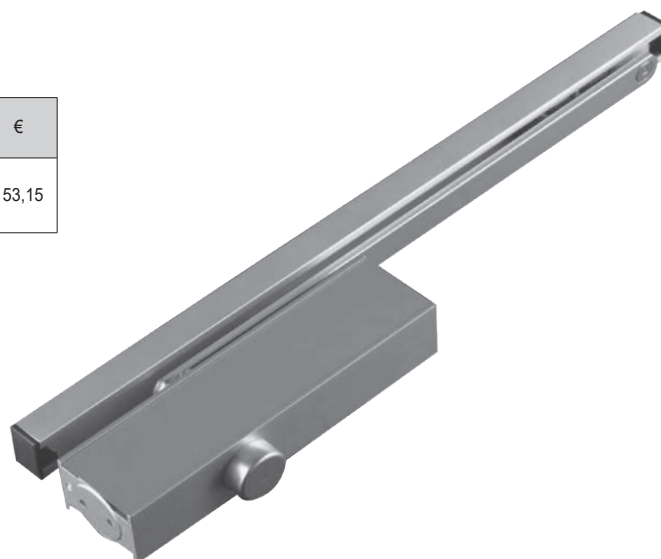

CODICE e DESCRIZIONE  
CODE and DESCRIPTION

FINITURE  
FINISHINGS

PCS/BOX

**812-5**

Chiudiporta  
con 4 valvole di regolazione

ARG  
NEO

1  
1

*Door closer*

CODE	DIMENSIONI						PORTATA (Kg)	LARGHEZZA	FUNZIONE	€
	A	B	C	D	E	F				
812-5CD	226	60	43,5	44	135	25	25-120	≤ 1200	con braccio a gomito con fermo	190,30



CODE	DIMENSIONI						PORTATA (Kg)	LARGHEZZA	FUNZIONE	€
	A	B	C	D	E	F				
812-5H	226	60	43,5	44	135	25	25-120	≤ 1200	con braccio a slitta con fermo	175,30

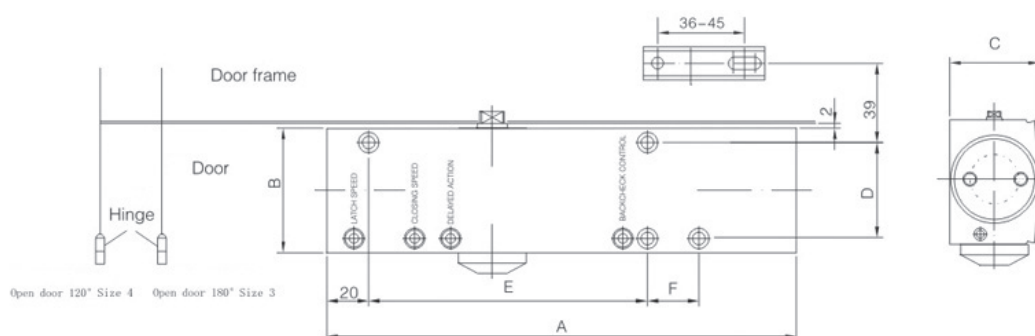

**kt** SERRATURE  
CILINDRI



CODICE e DESCRIZIONE  
CODE and DESCRIPTION

FINITURE  
FINISHINGS

€

PCS/BOX

## CX410K-S

Serratura magnetica con bordo tondo  
foro chiave completa di incontro in PVC

FRONTALE	ENTRATA	FINITURE	
		OLV	CHS
18x196	50	12,65	14,30

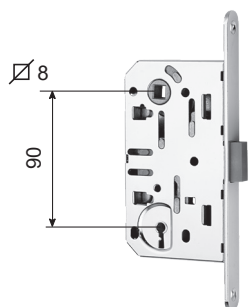

## CX410C-S

Serratura magnetica con bordo tondo  
foro cilindro completa di incontro in PVC

FRONTALE	ENTRATA	FINITURE
		CHS
18x196	50	18,05

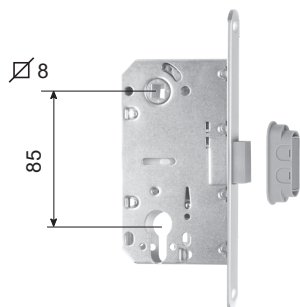

## CX410B-S

Serratura magnetica con bordo tondo  
foro WC completa di incontro in PVC

FRONTALE	ENTRATA	FINITURE
		CHS
18x196	50	16,95

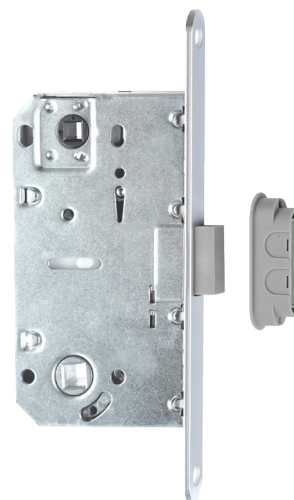
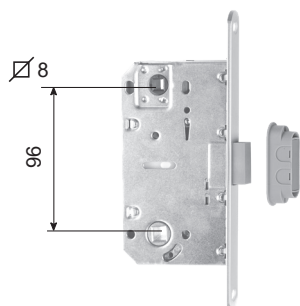

CODICE e DESCRIZIONE  
CODE and DESCRIPTION

FINITURE  
FINISHINGS

€

PCS/BOX

## SD410K-S

Serratura meccanica con bordo tondo  
foro chiave completa di incontro in PVC

FRONTALE	ENTRATA	FINITURE			
		OLV	CHS	CHL	BRY
18x196	50	9,80	10,10	10,85	10,85

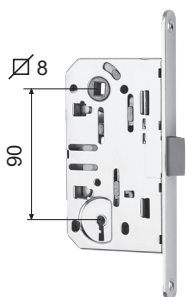

## SD410C-S

Serratura meccanica con bordo tondo  
foro cilindro completa di incontro in PVC

FRONTALE	ENTRATA	FINITURE
18x196	50	CHS
		14,10

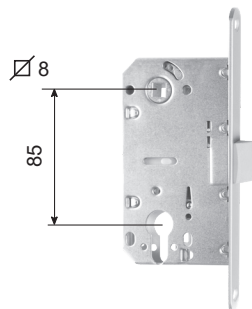

## SD410B-S

Serratura meccanica con bordo tondo  
foro WC completa di incontro in PVC

FRONTALE	ENTRATA	FINITURE
18x196	50	CHS
		13,60

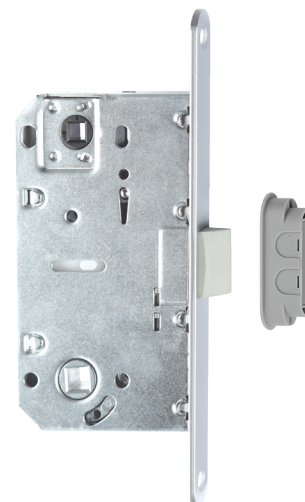
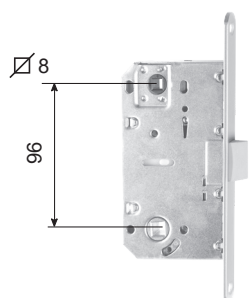



CODICE e DESCRIZIONE  
CODE and DESCRIPTION

FINITURE  
FINISHINGS

€

PCS/BOX

## SD410K-S-193

Serratura meccanica con bordo tondo  
foro chiave completa di incontro metallico

FRONTALE	ENTRATA	FINITURE	
		OLV	CHS
18x196	50	10,10	10,40

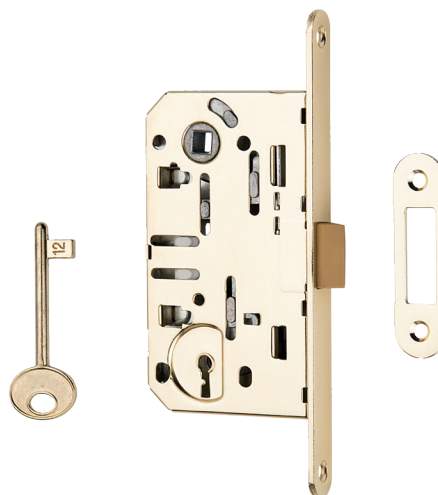
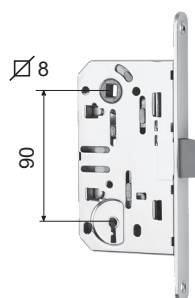

## SD410C-S-193

Serratura meccanica con bordo tondo  
foro cilindro completa di incontro in PVC

FRONTALE	ENTRATA	FINITURE	
		CHS	
18x196	50	14,40	

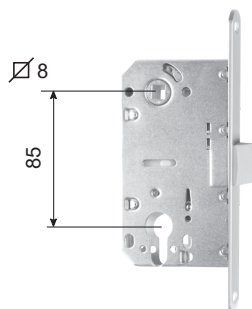

## SD410B-S-193

Serratura meccanica con bordo tondo  
foro WC completa di incontro in PVC

FRONTALE	ENTRATA	FINITURE	
		CHS	
18x196	50	13,90	

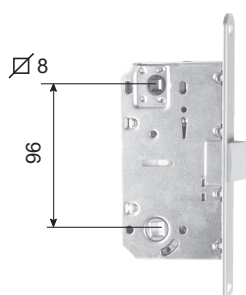

CODICE e DESCRIZIONE  
CODE and DESCRIPTION

FINITURE  
FINISHINGS

€

PCS/BOX

## 3090

Serratura grande con bordo tondo  
scrocco + mandata - foro chiave

FRONTALE	ENTRATA	FINITURE	
		OLV	CHS
22x238	50	9,60	10,00

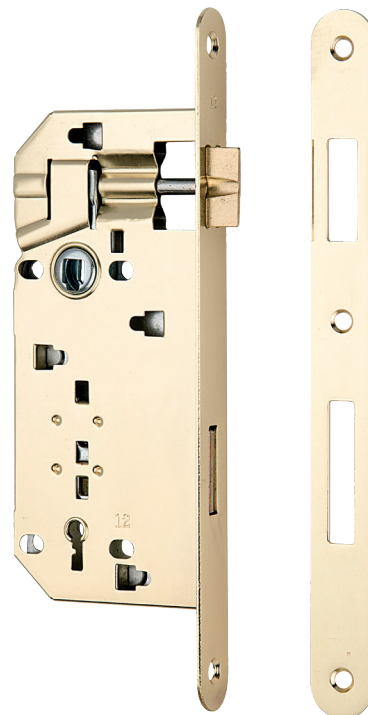
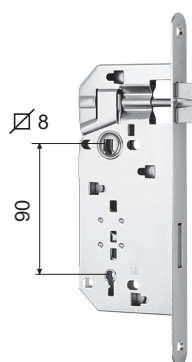

## 6460

Serratura piccola con bordo tondo  
scrocco + mandata - foro chiave

FRONTALE	ENTRATA	FINITURE		
		OLV	CHS	CHL
20x188	50	8,00	8,20	8,95

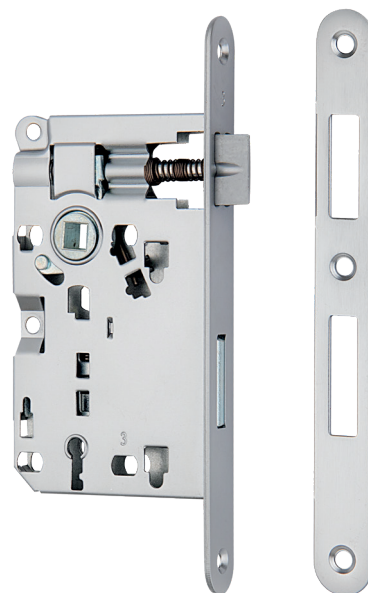
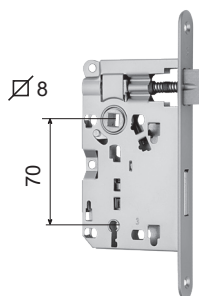

CODICE e DESCRIZIONE  
CODE and DESCRIPTION

FINITURE  
FINISHINGS

€

PCS/BOX

**3045**

Serratura grande con bordo tondo  
scrocco + mandata - foro cilindro

FRONTALE	ENTRATA	FINITURE	
		OLV	CHS
22x238	50	15,75	16,10

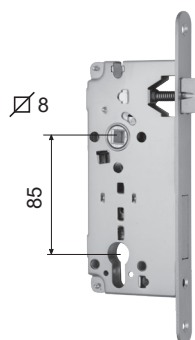

**9171C-1**

Serratura piccola con bordo tondo  
scrocco + mandata - foro cilindro

CODICE	FRONTALE	ENTRATA	FINITURE		
			OLV	CHS	BRG
9171C-1-18	18x196	50	14,30	14,55	16,80
9171C-1-22	22x196	50	14,60	14,85	17,10

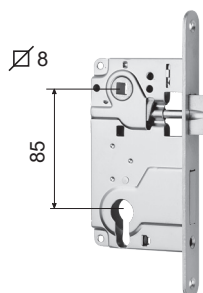

CODICE e DESCRIZIONE  
CODE and DESCRIPTION

FINITURE  
FINISHINGS

€

PCS/BOX

Doppio cilindro **ottone** universale  
sagomato - 3 chiavi

CODICE	LUNGHEZZA			FINITURE	
	A+B	A	B	OLV	CHS
CYL2535NK	60	25	35	10,80	11,40
CYL3030NK	60	30	30	10,80	11,40
CYL3040NK	70	30	40	12,80	13,60
CYL3535NK	70	35	35	12,80	13,60
CYL3545NK	80	35	45	14,80	15,60

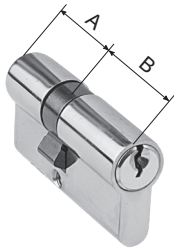

Doppio cilindro **ottone** europeo  
sagomato - 5 chiavi piatte

CODICE	LUNGHEZZA			FINITURE
	A+B	A	B	CHS
CYL3040CK	70	30	40	21,00
CYL3535CK	70	35	35	21,00
CYL3545CK	80	35	45	23,00
CYL4040CK	80	40	40	23,00

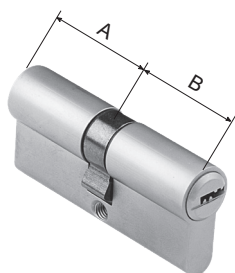

**kts** POMOLINI  
MANIGLIETTE  
REGGIMENSOLE

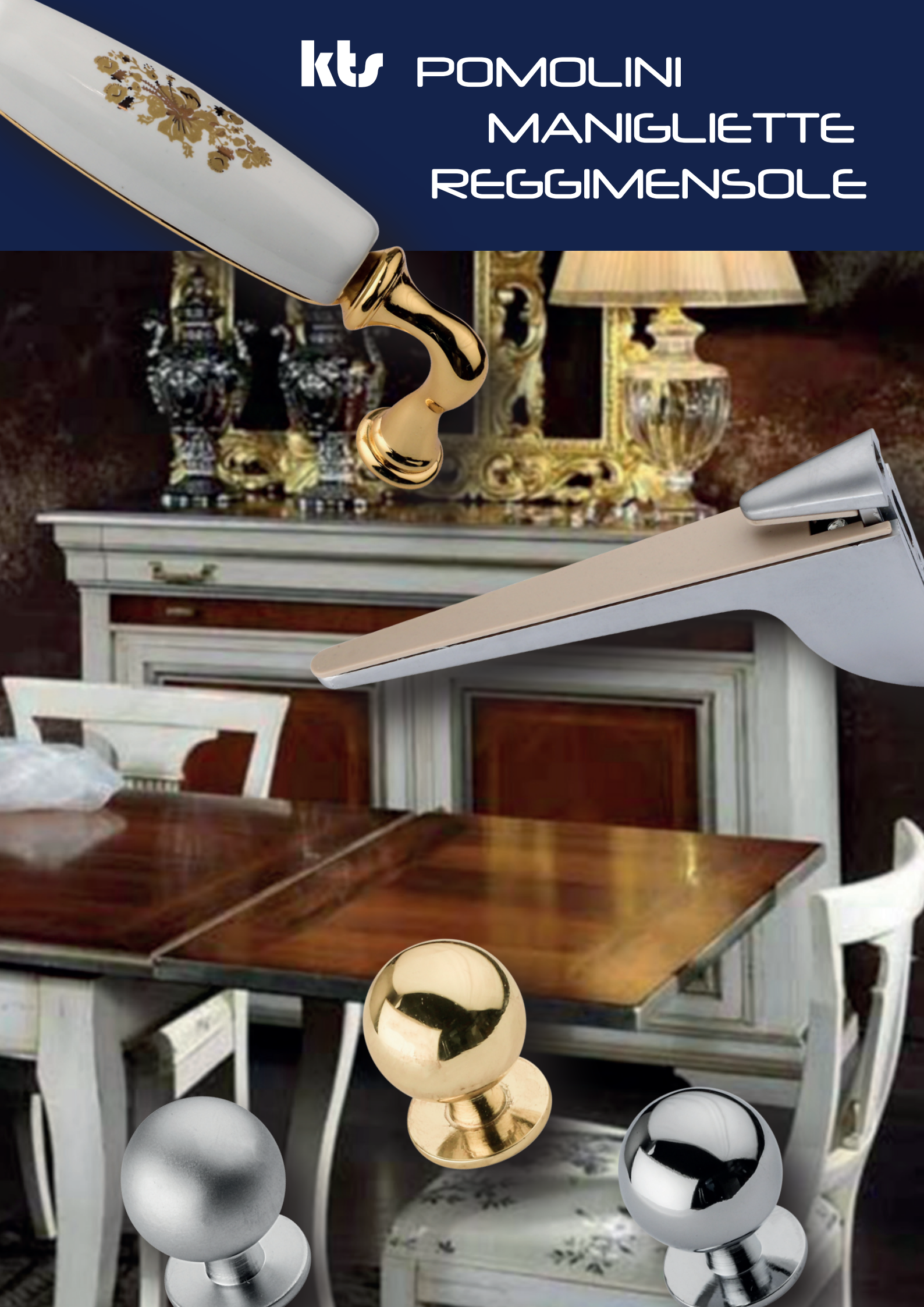

CODICE e DESCRIZIONE CODE and DESCRIPTION	FINITURE FINISHINGS	€	PCS/BOX
<b>2093</b>			
Pomolino ø 30 mm - h. 30 mm  <i>Cabinet knob</i> ø 30 mm - h. 30 mm	FAN	2,95	
<b>9033</b>			
Pomolino 24x24 mm - h. 20 mm  <i>Cabinet knob</i> 24x24 mm - h. 20 mm	CHS	2,70	
<b>8616EQ</b>			
Pomolino porcellana decorato ø 32 mm - h. 37 mm  <i>Cabinet knob</i> ø 32 mm - h. 37 mm	BRY	3,20	
<b>32EQ</b>			
Pomolino porcellana decorato ø 32 mm - h. 23 mm  <i>Cabinet knob</i> ø 32 mm - h. 23 mm		1,75	

CODICE e DESCRIZIONE  
CODE and DESCRIPTION

FINITURE  
FINISHINGS

€

PCS/BOX

## ZC3304

Pomolino  
ø 28 mm - h. 22 mm

OLV  
CHL

3,05  
3,25

*Cabinet knob*  
ø 28 mm - h. 22 mm



## ZC3778

Pomolino  
24x15 mm

OLV  
CHL

2,15  
2,35

*Cabinet knob*  
24x15 mm



## ZC5028

Pomolino  
ø 20 mm - h. 27 mm

OLV  
CHS  
CHL

2,85  
3,35  
3,05

*Cabinet knob*  
ø 20 mm - h. 27 mm



## ZC5407

Pomolino  
31x31 mm - h. 25 mm

CHS

4,25

*Cabinet knob*  
31x31 mm - h. 25 mm



## ZC5408



Pomolino  
25x25 mm - h. 24 mm

CHS  
CHL

2,80  
2,50

*Cabinet knob*  
25x25 mm - h. 24 mm



CODICE e DESCRIZIONE CODE and DESCRIPTION	FINITURE FINISHINGS	€	PCS/BOX	
<b>ZC5426</b>				
Pomolino ø 30 mm  Cabinet knob ø 30 mm	BRY	2,60		
<b>ZC5427</b>				
Pomolino ø 31 mm  Cabinet knob ø 31 mm	BRY	1,60		
<b>ZC5589</b>				
Pomolino 22x40 mm  Cabinet knob 22x40 mm	CHS CHL	2,50 2,40		
<b>ZC5637</b>				
Pomolino ø 30 mm - h. 24 mm  Cabinet knob ø 30 mm - h. 24 mm	CHL	2,95		
<b>ZC5639</b>				
Pomolino ø 18 mm - h. 27 mm  Cabinet knob ø 18 mm - h. 27 mm	OLV CHS CHL	2,50 2,70 2,60		



CODICE e DESCRIZIONE CODE and DESCRIPTION	FINITURE FINISHINGS	€	PCS/BOX							
<b>8556K</b>										
Maniglietta 96 mm Furniture handle 96 mm	BRY	5,15								
<b>8556EQ</b>										
Maniglietta 96 mm Furniture handle 96 mm	BRY	5,15								
<b>B8218K</b>										
Maniglietta 96 mm Furniture handle 96 mm	BRY	5,40								
<b>B8218EQ</b>										
Maniglietta 96 mm Furniture handle 96 mm	BRY	5,40								
<b>B8247K</b>										
Maniglietta 96 mm Furniture handle 96 mm										
	<table border="1"> <thead> <tr> <th>misure/ sizes</th> <th>BRY</th> </tr> </thead> <tbody> <tr> <td>96</td> <td>5,70</td> </tr> <tr> <td>128</td> <td>7,65</td> </tr> </tbody> </table>	misure/ sizes	BRY	96	5,70	128	7,65			
misure/ sizes	BRY									
96	5,70									
128	7,65									
<b>B8247H</b>										
Maniglietta 96 mm Furniture handle 96 mm										
	<table border="1"> <thead> <tr> <th>misure/ sizes</th> <th>ORO</th> </tr> </thead> <tbody> <tr> <td>96</td> <td>7,00</td> </tr> <tr> <td>128</td> <td>8,65</td> </tr> </tbody> </table>	misure/ sizes	ORO	96	7,00	128	8,65			
misure/ sizes	ORO									
96	7,00									
128	8,65									

CODICE e DESCRIZIONE  
CODE and DESCRIPTION

FINITURE  
FINISHINGS

€

PCS/BOX

**073**

*Maniglietta*

*Furniture handle*

misure/ sizes	CHL	CHS
160	7,30	7,50
192	7,50	7,70
224	8,55	8,75



**3018**

*Maniglietta*

*Furniture handle*

misure/ sizes	CHL	CHS
96	4,60	4,80
128	5,45	5,65
160	6,90	7,10
192	7,65	7,95
224	8,65	8,95
256	9,75	10,15
320	13,60	14,00



**3019**

*Maniglietta*

*Furniture handle*

misure/ sizes	CHL	CHS
64	3,30	3,60
96	4,00	4,30
128	5,15	5,45
160	5,90	6,20
192	6,80	7,10
224	7,50	7,80
288	9,35	9,75



CODICE e DESCRIZIONE  
CODE and DESCRIPTION

FINITURE  
FINISHINGS

€

PCS/BOX

**3020**

*Maniglietta*

*Furniture handle*

misure/ sizes	CHL	CHS
96	3,70	3,90
128	4,80	5,00
160	5,55	5,75
192	6,45	6,65
224	7,50	7,70



**3021**

*Maniglietta*

*Furniture handle*

misure/ sizes	CHS
64	5,90
96	7,10
128	8,55
160	9,50
224	12,05
288	15,15



**3022**

*Maniglietta*

*Furniture handle*

misure/ sizes	CHL	CHS
96	2,15	2,35
128	2,75	2,95



CODICE e DESCRIZIONE  
CODE and DESCRIPTION

FINITURE  
FINISHINGS

€

PCS/BOX

**3038**

*Maniglietta*

*Furniture handle*

misure/ sizes	CHL	CHS
96	1,50	1,80
128	2,20	2,50



**80561**

*Maniglietta 96 mm*

CHS

6,95

*Furniture handle 96 mm*



**81198**

*Maniglietta 160 mm*

CHS

6,10

*Furniture handle 160 mm*



CODICE e DESCRIZIONE  
CODE and DESCRIPTION

FINITURE  
FINISHINGS

€

PCS/BOX

**2093**

*Maniglietta*

*Furniture handle*

misure/ sizes	FAN
64	2,80
96	4,95



**906**

*Maniglietta*

*Furniture handle*

misure/ sizes	CHL	CHS
96	2,50	2,70
128	2,95	3,15



**9072**

*Maniglietta*

*Furniture handle*

misure/ sizes	CHL
128	3,75
160	5,15
192	6,35



**9083**

*Maniglietta 96 mm*

CHL 2,65

*Furniture handle 96 mm*

CHS 2,75



CODICE e DESCRIZIONE  
CODE and DESCRIPTION

FINITURE  
FINISHINGS

€

PCS/BOX

### ZC3605

Maniglietta 64 mm

CHS

2,05

Furniture handle 64 mm



### ZC3800

Maniglietta 224 mm

CHS

8,30

Furniture handle 224 mm



### ZC5106

Maniglietta

Furniture handle

misura/ sizes	CHS
128	6,95
160	7,55



### ZC5145

Maniglietta

Furniture handle

misura/ sizes	CHS
64	3,50
96	4,10



CODICE e DESCRIZIONE  
CODE and DESCRIPTION

FINITURE  
FINISHINGS

€

PCS/BOX

**ZC5157**

*Maniglia 128 mm*  
*Furniture handle 128 mm*

BRY

5,70



**ZC5524**

*Maniglia 96 mm*  
*Furniture handle 96 mm*

BRY

3,15



**ZC5671**

*Maniglia 160 mm*  
*Furniture handle 160 mm*

CHS

6,80





**ZC5536**

*Maniglia 128 mm*  
*Furniture handle 128 mm*

CHL

4,35



CODICE e DESCRIZIONE CODE and DESCRIPTION	FINITURE FINISHINGS	€	PCS/BOX	
<b>3041</b>				
<i>Reggimensola</i>	CHS	6,90		
<i>Shelf</i>	CHL	6,70		
<b>3042</b>				
<i>Reggimensola</i>	CHS	9,50		
<i>Shelf</i>	CHL	9,30		
<b>3043L</b>				
<i>Reggimensola</i>	CHS	7,55		
<i>Shelf</i>	CHL	7,35		
<b>3043S</b>				
<i>Reggimensola</i>	CHS	6,20		
<i>Shelf</i>	CHL	6,00		
<b>3044</b>				
<i>Reggimensola</i>	CHS	3,00		
<i>Shelf</i>	CHL	2,80		
<b>3046</b>				
<i>Reggimensola</i>	CHS	5,10		
<i>Shelf</i>	CHL	4,90		
<b>3047</b>				
<i>Reggimensola</i>	CHS	3,45		
<i>Shelf</i>	CHL	3,25		



I N O X

# Maniglie - Handles



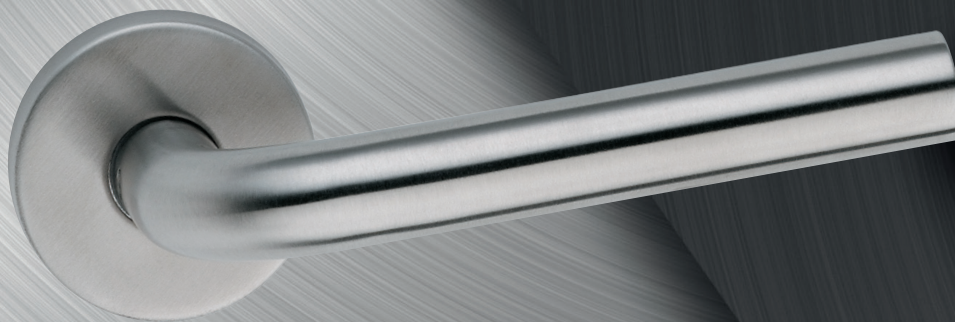

CODICE e DESCRIZIONE CODE and DESCRIPTION		FINITURE FINISHINGS	€	PCS/BOX
<b>LH003RR01</b>				
Maniglia su rosetta tonda <i>Handle with round rose</i>		INOX AISI 304 SATINATO	27,20	6
<b>LH003OR01</b>				
Maniglia su rosetta ovale <i>Handle with oval rose</i>		INOX AISI 304 SATINATO	28,50	6
<b>LH003DK02</b>				
Martellina DK con movimento in fibra <i>DK window handle</i>		INOX AISI 304 SATINATO	20,80	4



CODICE e DESCRIZIONE CODE and DESCRIPTION		FINITURE FINISHINGS	€	PCS/BOX
<b>LH006RR01</b>				
Maniglia su rosetta tonda <i>Handle with round rose</i>		INOX AISI 304 BICOLORE	33,20	6
<b>LH006OR01</b>				
Maniglia su rosetta ovale <i>Handle with oval rose</i>		INOX AISI 304 BICOLORE	38,50	6
<b>LH006DK02</b>				
Martellina DK con movimento in fibra <i>DK window handle</i>		INOX AISI 304 BICOLORE	24,10	4

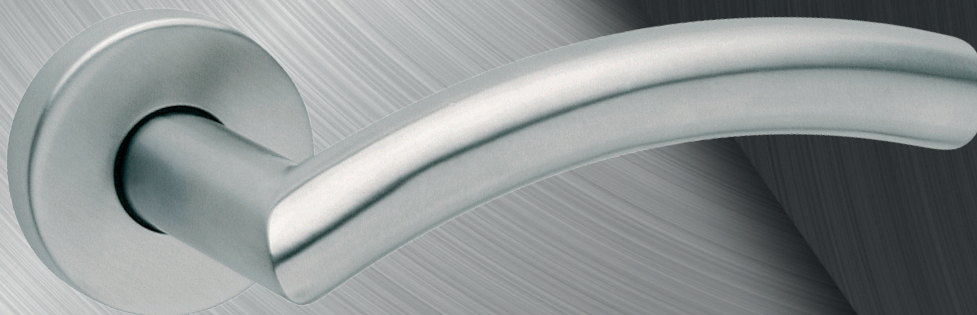

# LUNA

CODICE e DESCRIZIONE CODE and DESCRIPTION		FINITURE FINISHINGS	€	PCS/BOX
<b>LH004RR01</b>				
Maniglia su rosetta tonda <i>Handle with round rose</i>		INOX AISI 304 SATINATO	28,40	6
<b>LH004OR01</b>				
Maniglia su rosetta ovale <i>Handle with oval rose</i>		INOX AISI 304 SATINATO	29,70	6
<b>LH004DK02</b>				
Martellina DK con movimento in fibra <i>DK window handle</i>		INOX AISI 304 SATINATO	21,40	4

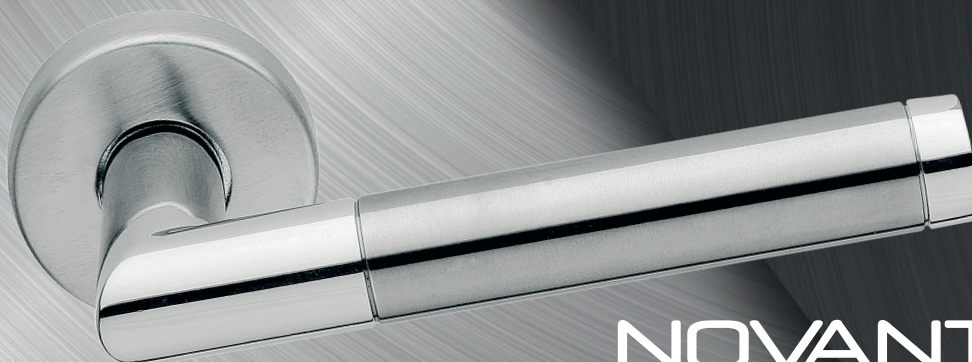

# NOVANTA bicolore

CODICE e DESCRIZIONE CODE and DESCRIPTION		FINITURE FINISHINGS	€	PCS/BOX
<b>LH005RR01</b>				
Maniglia su rosetta tonda <i>Handle with round rose</i>		INOX AISI 304 BICOLORE	33,20	6
<b>LH005OR01</b>				
Maniglia su rosetta ovale <i>Handle with oval rose</i>		INOX AISI 304 BICOLORE	38,50	6
<b>LH005DK02</b>				
Martellina DK con movimento in fibra <i>DK window handle</i>		INOX AISI 304 BICOLORE	24,10	4

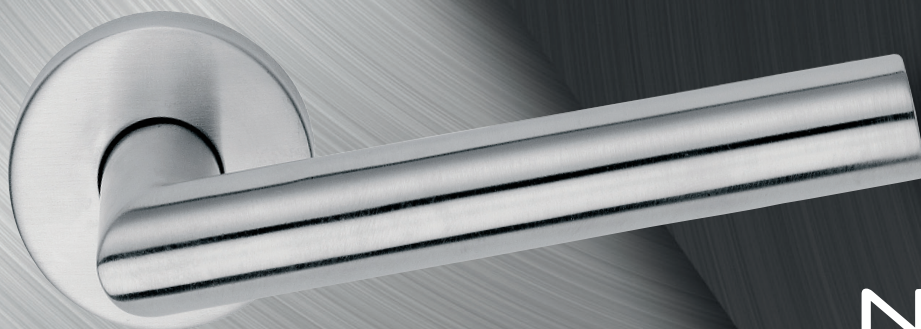

# NOVANTA

CODICE e DESCRIZIONE CODE and DESCRIPTION		FINITURE FINISHINGS	€	PCS/BOX
<b>LH001RR01</b>				
Maniglia su rosetta tonda <i>Handle with round rose</i>		INOX AISI 304 SATINATO	27,20	6
<b>LH001OR01</b>				
Maniglia su rosetta ovale <i>Handle with oval rose</i>		INOX AISI 304 SATINATO	28,50	6
<b>LH001DK02</b>				
Martellina DK con movimento in fibra <i>DK window handle</i>		INOX AISI 304 SATINATO	20,80	4

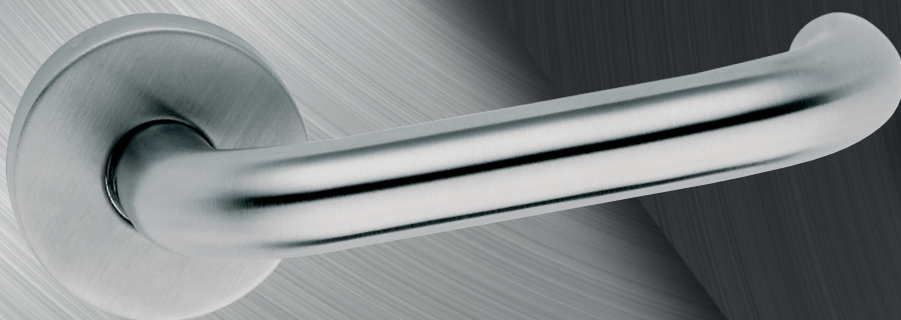

# UNI

CODICE e DESCRIZIONE CODE and DESCRIPTION		FINITURE FINISHINGS	€	PCS/BOX
<b>LH002RR01</b>				
Maniglia su rosetta tonda <i>Handle with round rose</i>		INOX AISI 304 SATINATO	27,20	5
<b>LH002OR01</b>				
Maniglia su rosetta ovale <i>Handle with oval rose</i>		INOX AISI 304 SATINATO	28,50	5
<b>LH002DK02</b>				
Martellina DK con movimento in fibra <i>DK window handle</i>		INOX AISI 304 SATINATO	20,80	5

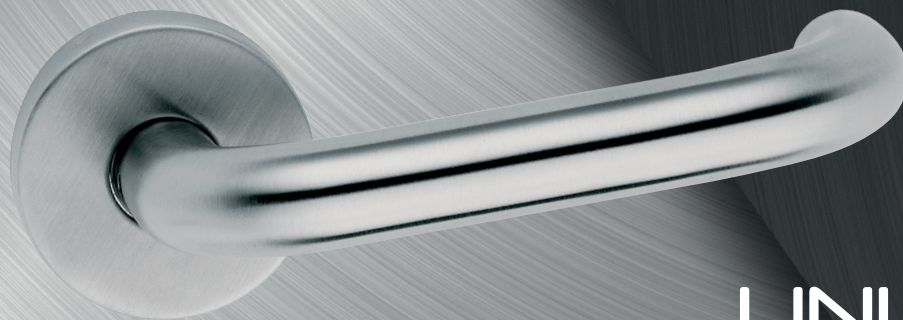

## UNI metal base

CODICE e DESCRIZIONE CODE and DESCRIPTION		FINITURE FINISHINGS	€	PCS/BOX
<b>LH002IRR01 (base metallica)</b>				
Maniglia su rosetta tonda <i>Handle with round rose</i>		INOX AISI 304 SATINATO	29,40	5
<b>LH002IOR01 (base metallica)</b>				
Maniglia su rosetta ovale <i>Handle with oval rose</i>		INOX AISI 304 SATINATO	30,70	5
<b>LH002DK01 (base metallica)</b>				
Martellina DK con movimento metallico <i>DK window handle</i>		INOX AISI 304 SATINATO	21,20	4

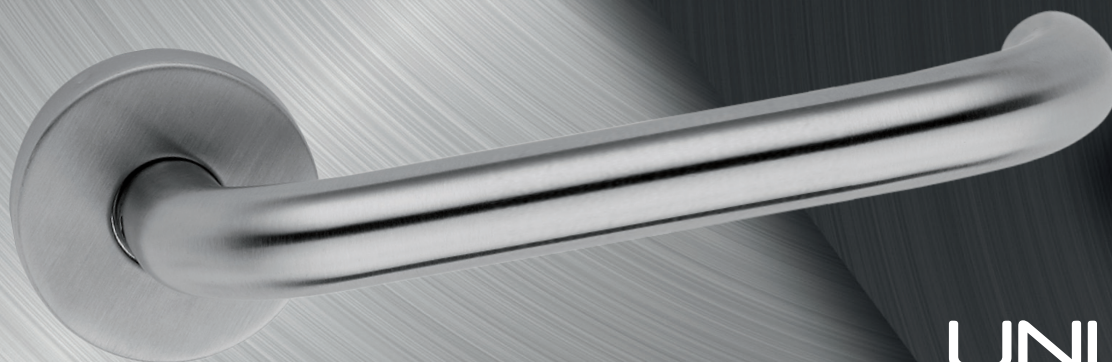

## UNI PLUS

CODICE e DESCRIZIONE CODE and DESCRIPTION		FINITURE FINISHINGS	€	PCS/BOX
<b>LH002BIRR01 (base metallica)</b>				
Maniglia su rosetta tonda <i>Handle with round rose</i>		INOX AISI 304 SATINATO	38,20	5
<b>LH002BIOR01 (base metallica)</b>				
Maniglia su rosetta ovale <i>Handle with oval rose</i>		INOX AISI 304 SATINATO	39,50	5

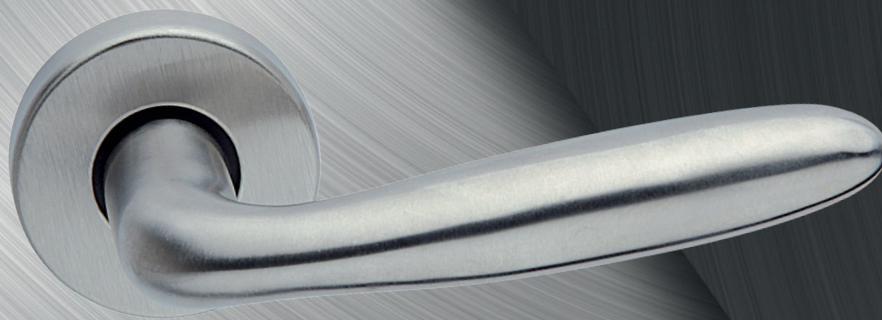

# YORK

CODICE e DESCRIZIONE CODE and DESCRIPTION		FINITURE FINISHINGS	€	PCS/BOX
<b>LH009RR01</b>				
Maniglia su rosetta tonda <i>Handle with round rose</i>		INOX AISI 304 SATINATO	42,70	6
<b>LH009OR01</b>				
Maniglia su rosetta ovale <i>Handle with oval rose</i>		INOX AISI 304 SATINATO	44,00	6
<b>LH009DK02</b>				
Martellina DK con movimento in fibra <i>DK window handle</i>		INOX AISI 304 SATINATO	28,70	4



# BETA

CODICE e DESCRIZIONE CODE and DESCRIPTION		FINITURE FINISHINGS	€	PCS/BOX
<b>LH008SR01</b>				
Maniglia su rosetta quadra <i>Handle with square rose</i>		INOX AISI 304 SATINATO	56,60	2
<b>LH008QR01</b>				
Maniglia su rosetta rettangolare <i>Handle with rectangular rose</i>		INOX AISI 304 SATINATO	61,00	2
<b>LH008DK04</b>				
Martellina DK con movimento in fibra <i>DK window handle</i>		INOX AISI 304 SATINATO	32,20	4

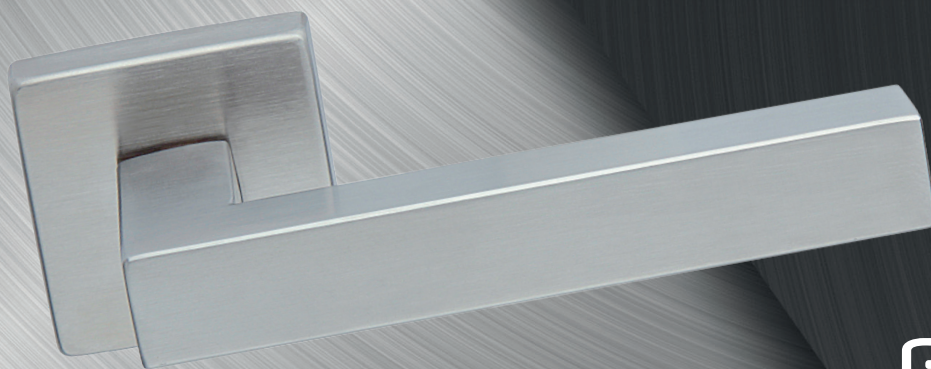

# GAMMA

CODICE e DESCRIZIONE CODE and DESCRIPTION		FINITURE FINISHINGS	€	PCS/BOX
<b>LH007SR01</b>				
Maniglia su rosetta quadra <i>Handle with square rose</i>		INOX AISI 304 SATINATO	49,90	2
<b>LH007QR01</b>				
Maniglia su rosetta rettangolare <i>Handle with rectangular rose</i>		INOX AISI 304 SATINATO	54,30	2
<b>LH007DK04</b>				
Martellina DK con movimento in fibra <i>DK window handle</i>		INOX AISI 304 SATINATO	28,90	4

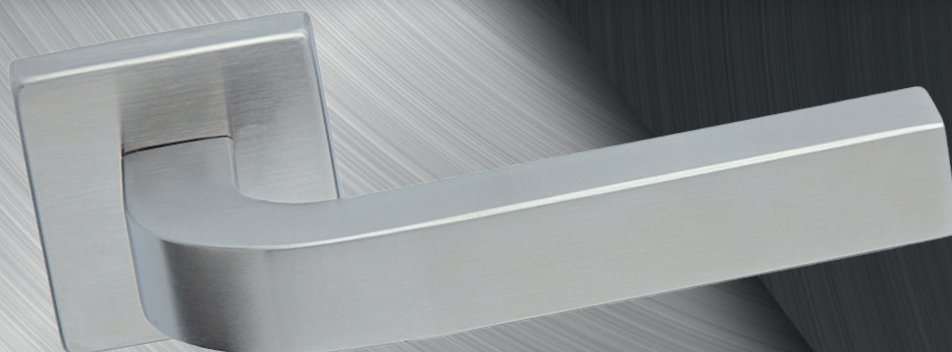

# LESMO

CODICE e DESCRIZIONE CODE and DESCRIPTION		FINITURE FINISHINGS	€	PCS/BOX
<b>LH012SR01</b>				
Maniglia su rosetta quadra <i>Handle with square rose</i>		INOX AISI 304 SATINATO	56,60	2
<b>LH012QR01</b>				
Maniglia su rosetta rettangolare <i>Handle with rectangular rose</i>		INOX AISI 304 SATINATO	61,00	2
<b>LH012DK04</b>				
Martellina DK con movimento in fibra <i>DK window handle</i>		INOX AISI 304 SATINATO	32,20	4



# Maniglioni - Pull handles



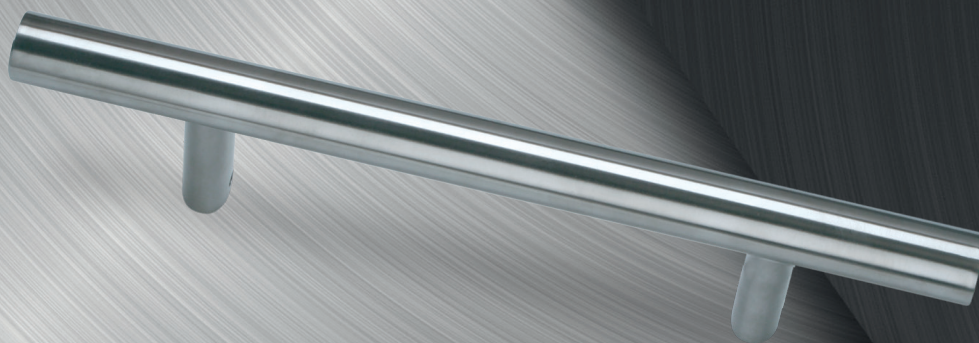

### PH006B

Maniglione INOX

SS Pull handle

CODE	Ø	Ø GAMBI DRITTI	INTERASSE	LUNGHEZZA	€	PCS/BOX
PH006B1	30	25	210	300	53,30	2
PH006B2	30	25	300	400	57,20	2
PH006B3	30	25	300	500	62,70	2
PH006B4	30	25	400	600	67,80	2
PH006B5	30	25	600	800	87,40	2
PH006B6	30	25	900	1200	113,80	2

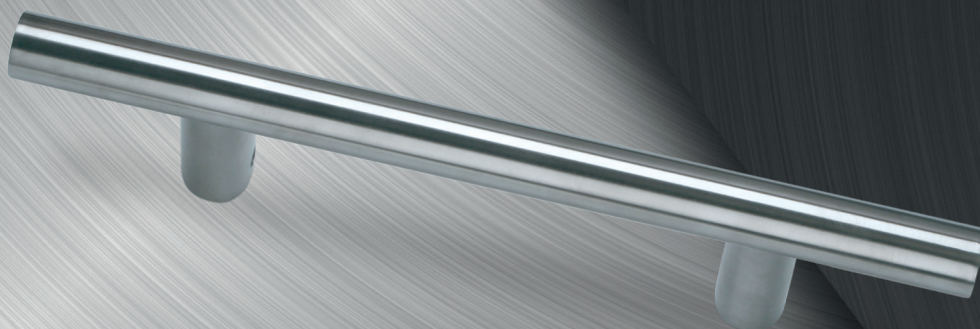
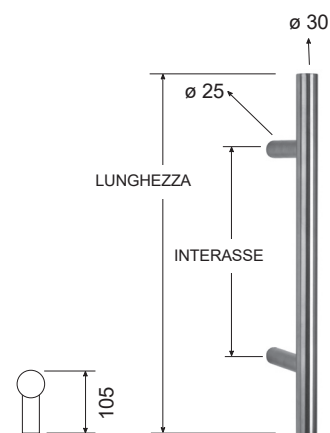

### PH006D

Maniglione INOX

SS Pull handle

CODE	Ø	Ø GAMBI DRITTI	INTERASSE	LUNGHEZZA	€	PCS/BOX
PH006D1	30	30	210	300	59,90	2
PH006D2	30	30	300	400	63,80	2
PH006D3	30	30	300	500	71,50	2
PH006D4	30	30	400	600	74,40	2
PH006D5	30	30	600	800	94,00	2
PH006D6	30	30	900	1200	120,40	2

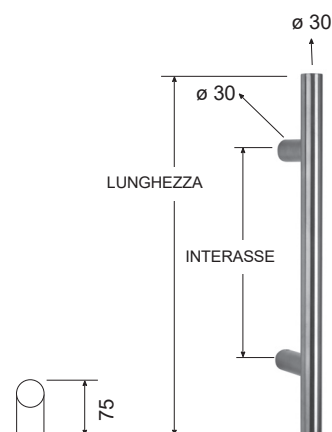

INOX  
SATINATO  
AISI  
304

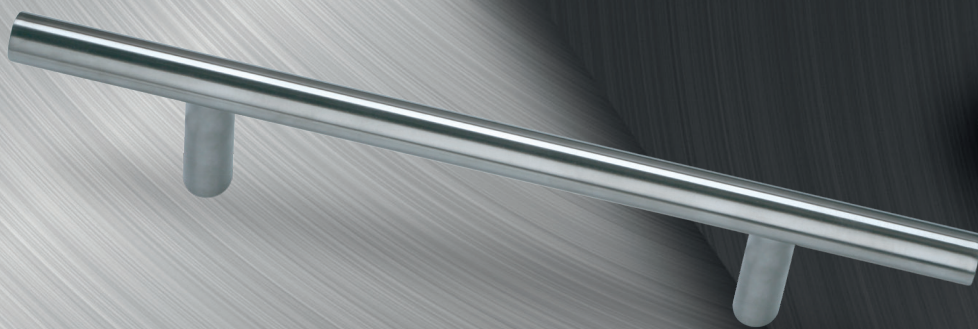

**PH006F**

Maniglione INOX

SS Pull handle

CODE	Ø	Ø GAMBI DRITTI	INTERASSE	LUNGHEZZA	€	PCS/BOX
PH006F3	25	25	300	500	77,80	2
PH006F4	25	25	400	600	81,20	2

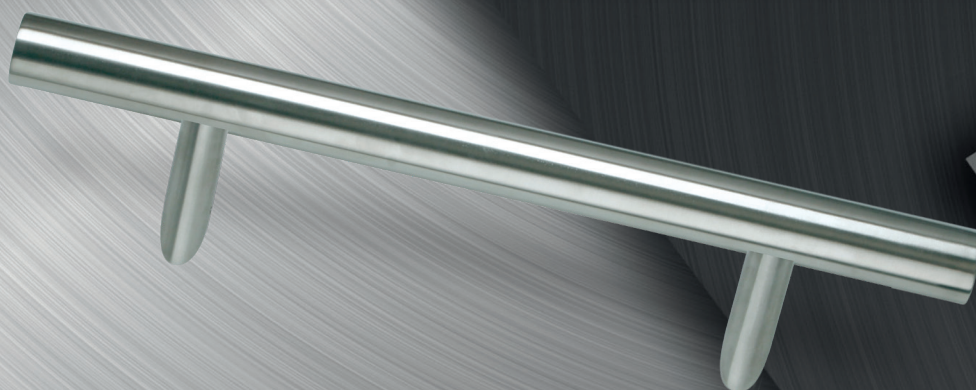
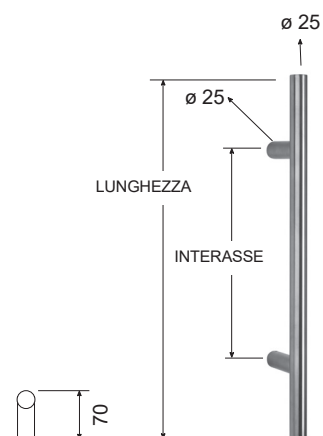

INOX  
SATINATO  
AISI  
304

INCLINATO/SLANTED

**PH006A**

Maniglione INOX

SS Pull handle

CODE	Ø	Ø GAMBI ZANCATI	INTERASSE	LUNGHEZZA	€	PCS/BOX
PH006A1	30	25	210	300	60,50	2
PH006A2	30	25	300	400	66,00	2
PH006A3	30	25	300	500	73,40	2
PH006A4	30	25	400	600	80,70	2
PH006A5	30	25	600	800	91,70	2
PH006A6	30	25	900	1200	119,20	2

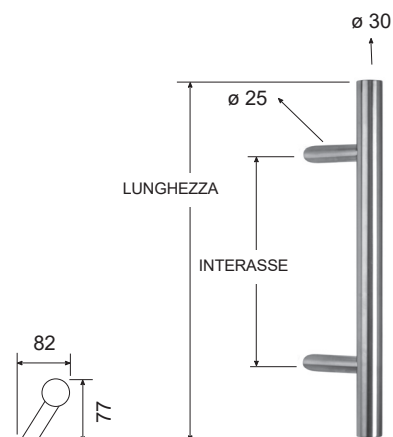

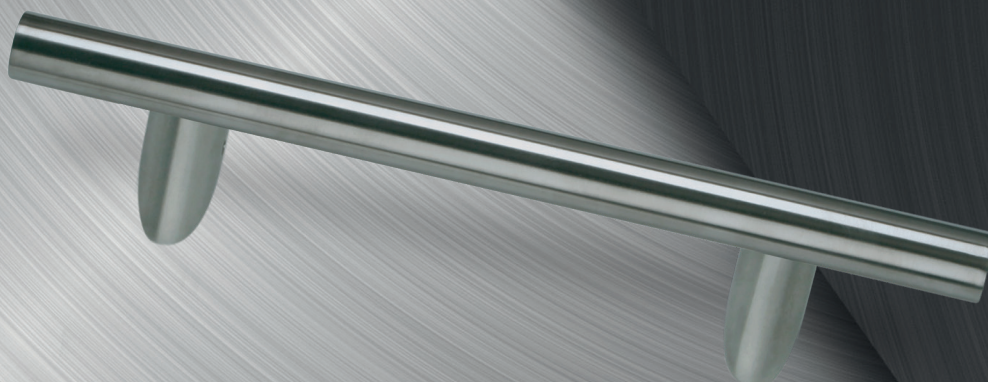

**PH006C**

Maniglione INOX

*SS Pull handle*

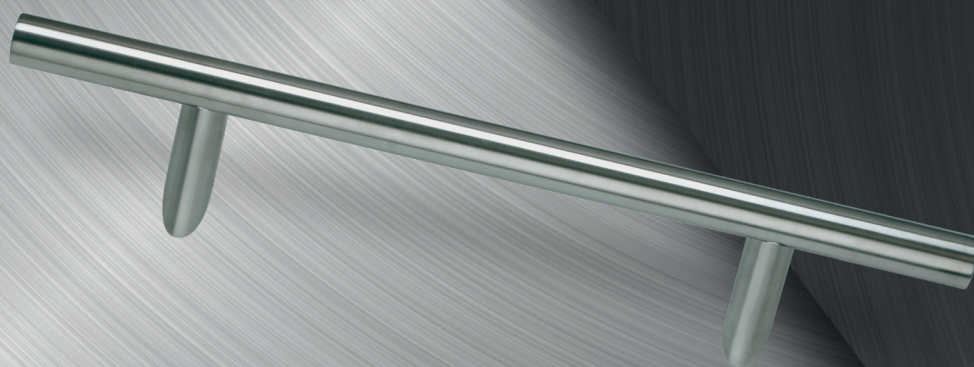
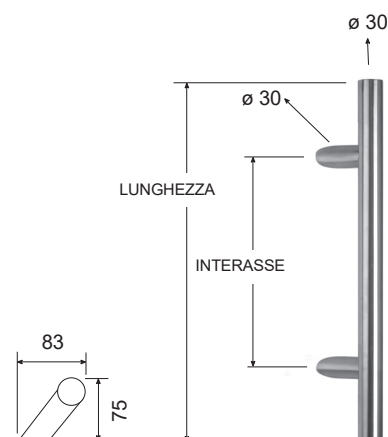
CODE	Ø	Ø GAMBI ZANCATI	INTERASSE	LUNGHEZZA	€	PCS/BOX
PH006C1	30	30	210	300	71,50	2
PH006C2	30	30	300	400	77,00	2
PH006C3	30	30	300	500	84,40	2
PH006C4	30	30	400	600	91,70	2
PH006C5	30	30	600	800	102,70	2
PH006C6	30	30	900	1200	130,20	2



**PH006E**

Maniglione INOX

*SS Pull handle*

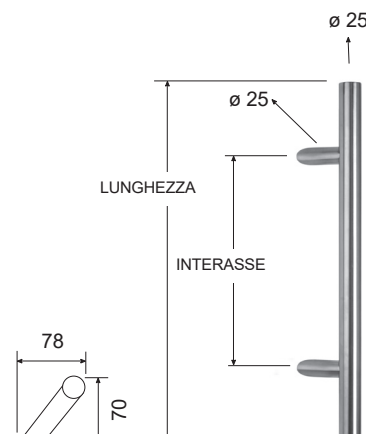
CODE	Ø	Ø GAMBI ZANCATI	INTERASSE	LUNGHEZZA	€	PCS/BOX
PH006E3	25	25	300	500	90,60	2
PH006E4	25	25	400	600	97,70	2

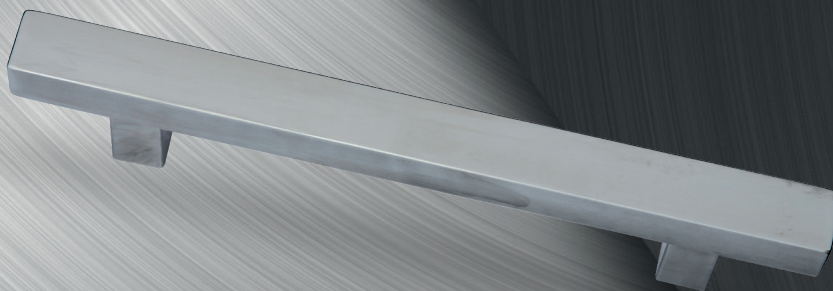



INOX  
SATINATO  
AISI  
304

### PH006SB

Maniglione INOX

SS Pull handle

CODE	∩	∩ GAMBI DRITTI	INTERASSE	LUNGHEZZA	€	PCS/BOX
PH006SB1	25X25	20x20	210	300	82,50	2
PH006SB2	25X25	20x20	300	400	91,20	2
PH006SB3	25X25	20x20	300	500	99,90	2
PH006SB4	25X25	20x20	400	600	108,80	2
PH006SB5	25X25	20x20	600	800	130,60	2
PH006SB6	25X25	20x20	900	1200	161,60	2

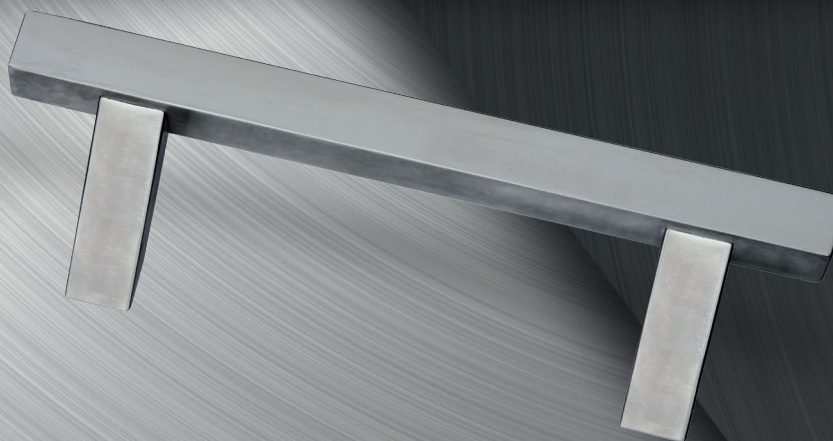
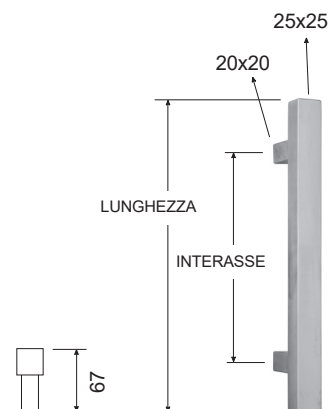

INOX  
SATINATO  
AISI  
304

INCLINATO/SLANTED

### PH006SA

Maniglione INOX

SS Pull handle

CODE	∩	∩ GAMBI ZANCATI	INTERASSE	LUNGHEZZA	€	PCS/BOX
PH006SA1	25X25	25X25	210	300	111,90	2
PH006SA2	25X25	25X25	300	400	120,70	2
PH006SA3	25X25	25X25	300	500	129,50	2
PH006SA4	25X25	25X25	400	600	138,30	2
PH006SA5	25X25	25X25	600	800	160,30	2
PH006SA6	25X25	25X25	900	1200	191,20	2

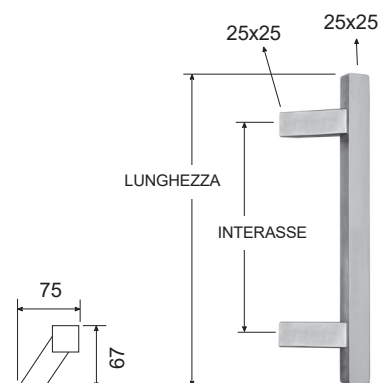

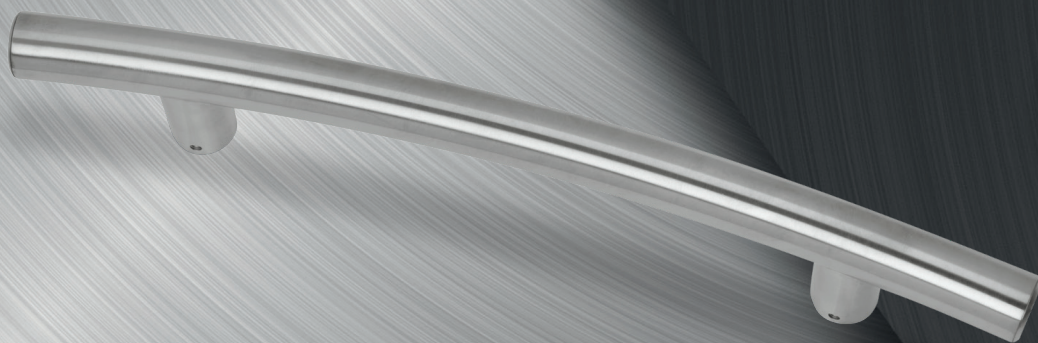

### PH010

Maniglione INOX

SS Pull handle

CODE	Ø	Ø GAMBI DRITTI	INTERASSE	LUNGHEZZA	Z	€	PCS/BOX
PH010A	30	30	300	500	50	93,50	2
PH010B	30	30	500	700	70	98,50	2
PH010C	30	30	800	1000	90	113,00	2

RAGGIO FISSO 1100

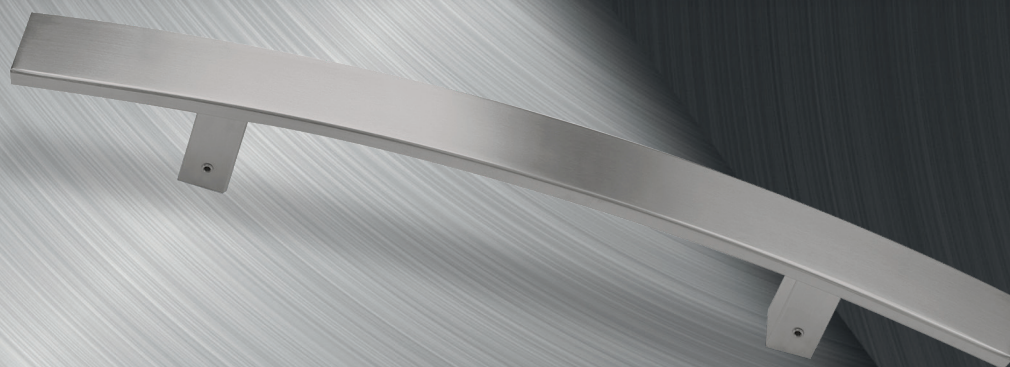
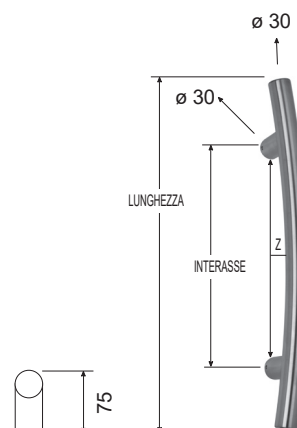

### PH015

Maniglione INOX

SS Pull handle

CODE	▧	▧ GAMBI DRITTI	INTERASSE	LUNGHEZZA	€	PCS/BOX
PH015A	40x10	25x25	300	500	95,50	2
PH015B	40x10	25x25	400	600	99,90	2
PH015C	40x10	25x25	600	800	104,30	2

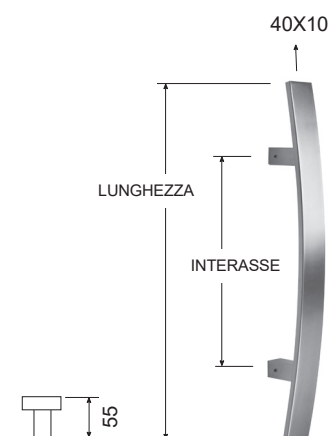

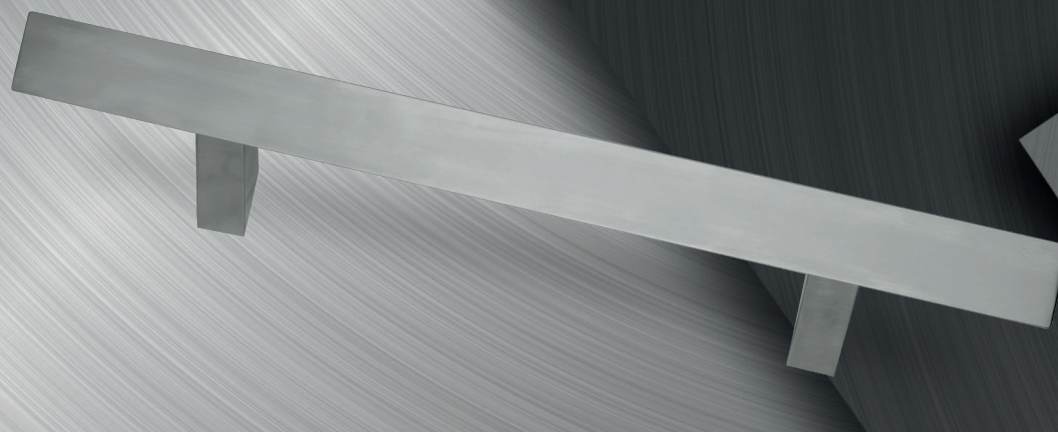

**PH014**

Maniglione INOX

*SS Pull handle*

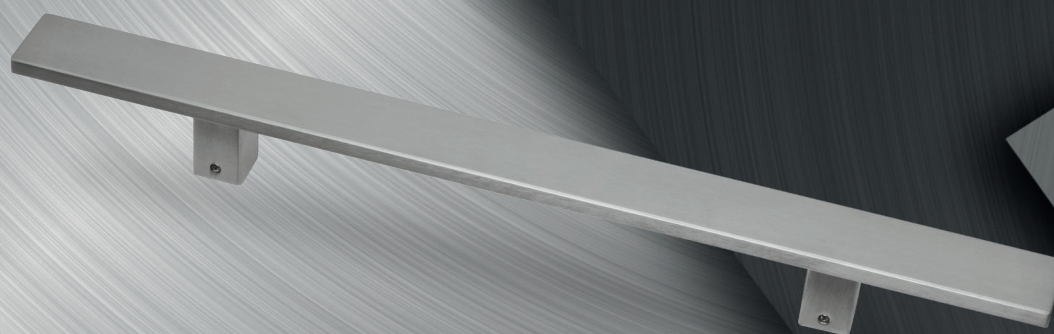
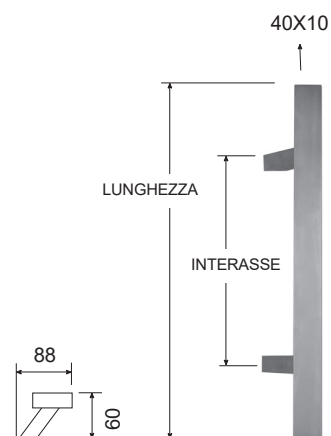

CODE		∅ GAMBI ZANCATI	INTERASSE	LUNGHEZZA	€	PCS/BOX
PH014A	40x10	25x25	300	500	97,40	2
PH014B	40x10	25x25	400	600	102,90	2
PH014C	40x10	25x25	600	800	108,40	2



**PH004**

Maniglione INOX

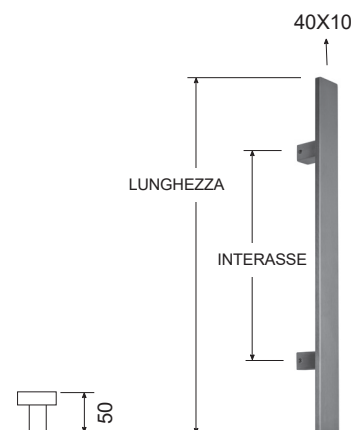
*SS Pull handle*

CODE		∅ GAMBI DRITTI	INTERASSE	LUNGHEZZA	€	PCS/BOX
PH004A	40x10	25x25	300	500	94,40	2
PH004B	40x10	25x25	400	600	98,80	2
PH004C	40x10	25x25	600	800	103,20	2

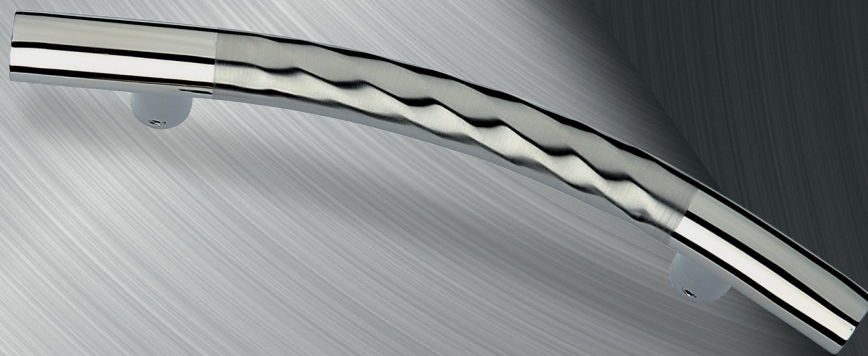



**PH012**

Maniglione INOX

SS Pull handle

CODE	Ø	Ø GAMBI DRITTI	INTERASSE	LUNGHEZZA	Z	€	PCS/BOX
PH012	25	20	200	300	30	60,50	2

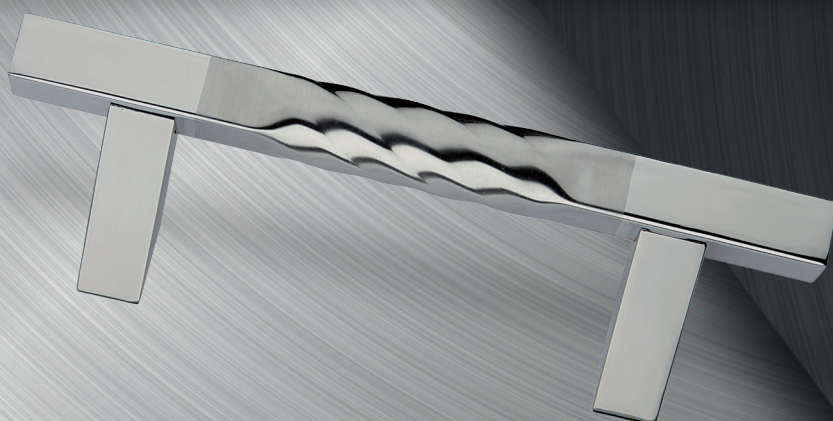
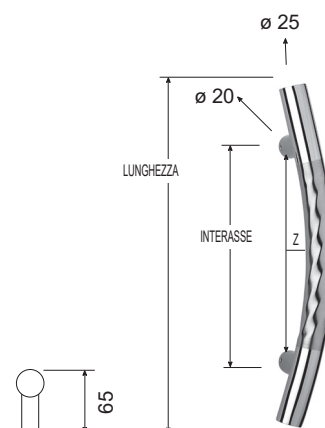

INCLINATO/SLANTED

**PH013**

Maniglione INOX

SS Pull handle

CODE	∇	∇ GAMBI ZANCATI	INTERASSE	LUNGHEZZA	€	PCS/BOX
PH013	25x25	25x25	200	300	71,50	2

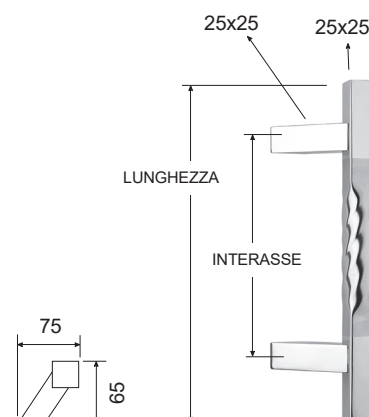



INOX  
BICOLORE  
AISI  
304

INOX  
SATINATO  
AISI  
304

INCLINATO/SLANTED

**PH017**

Maniglione INOX

SS Pull handle

CODE	Ø	INTERASSE	LUNGHEZZA	Z	€	PCS/BOX
PH017A	25	250	400	45	66,60	2
PH017A	25	250	400	45	72,10	2
PH017B	25	350	500	58	79,80	2
PH017B	25	350	500	58	85,30	2

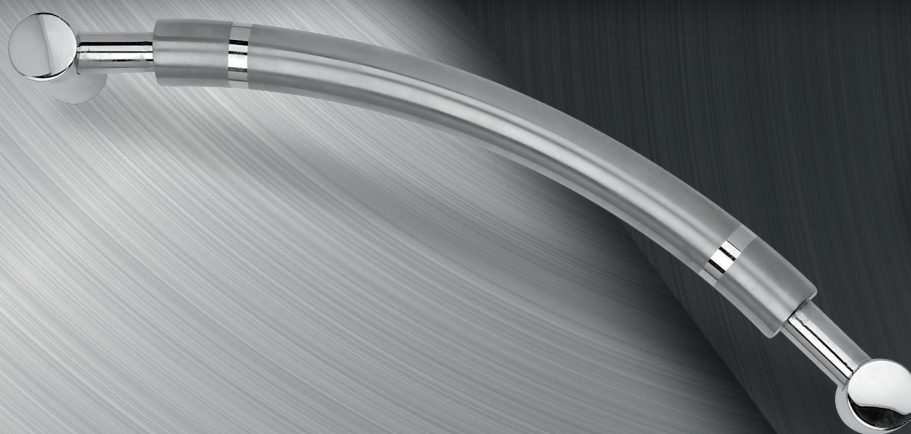
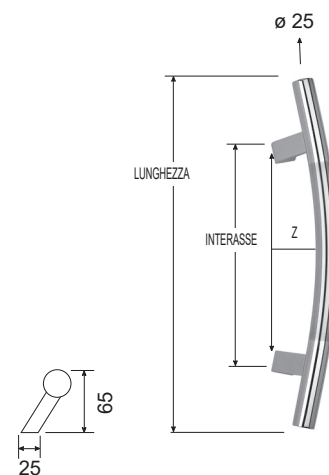

INOX  
BICOLORE  
AISI  
304

**PH011**

Maniglione INOX

SS Pull handle

CODE	Ø	INTERASSE	LUNGHEZZA	Z	€	PCS/BOX
PH011A	32	400	432	45	74,30	2
PH011B	32	500	532	80	83,30	2

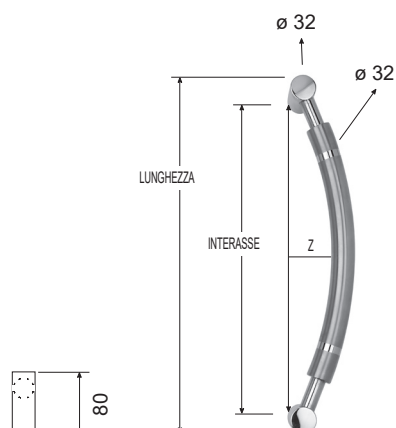

INOX  
SATINATO  
AISI  
304

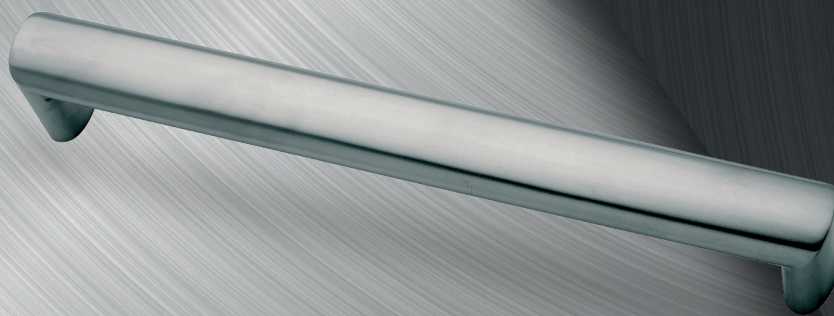

**PH009**

Maniglione INOX

*SS Pull handle*

CODE		INTERASSE	LUNGHEZZA	€	PCS/BOX
PH009A	20x40	350	370	103,90	2
PH009B	20x40	820	840	137,40	2

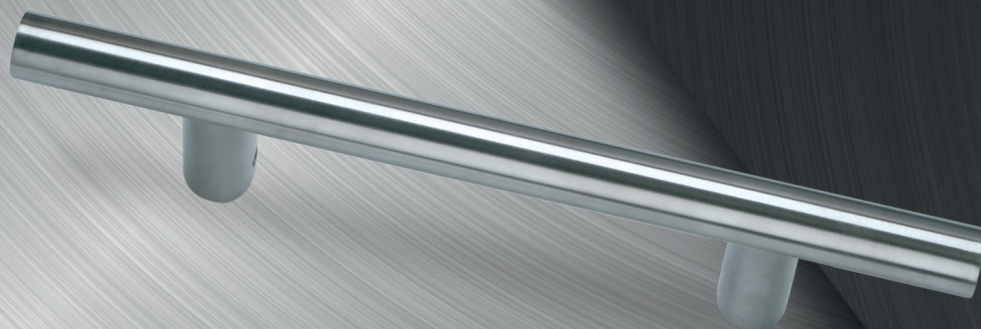
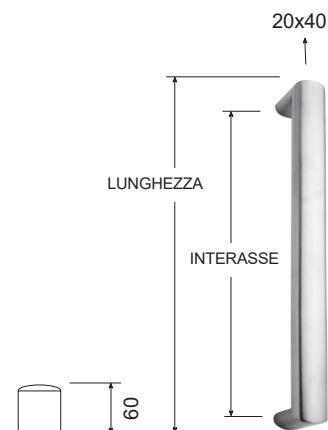

INOX  
SATINATO  
AISI  
304

**PH006**

Maniglione INOX

*SS Pull handle*

CODE	Ø	Ø GAMBI DRITTI	INTERASSE	LUNGHEZZA	€	PCS/BOX
PH006	32	30	350	500	52,40	2

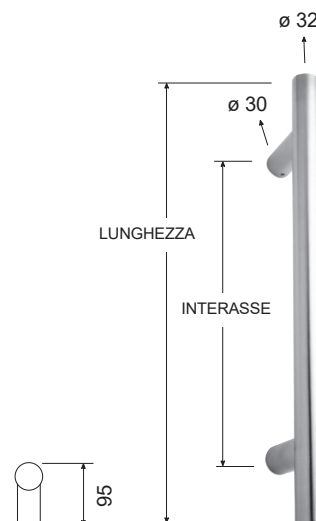

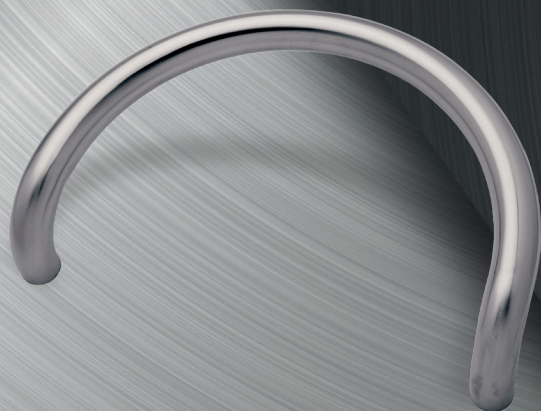

**PH003**

Maniglione INOX

*SS Pull handle*

CODE	Ø	INTERASSE	LUNGHEZZA	Z	€	PCS/BOX
PH003	32	350	382	230	60,80	2

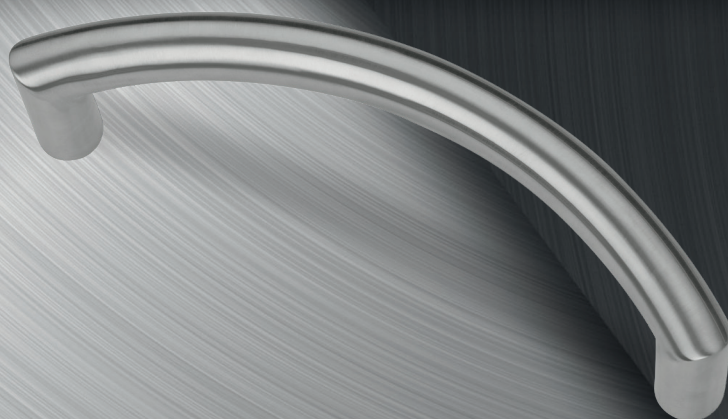
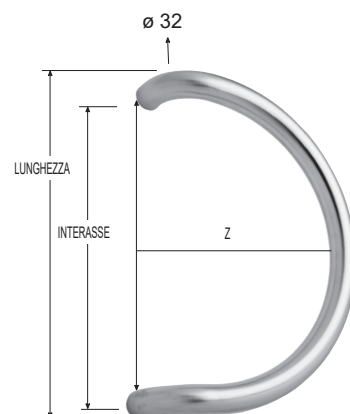

**PH007**

Maniglione INOX

*SS Pull handle*

CODE	Ø	INTERASSE	LUNGHEZZA	Z	€	PCS/BOX
PH007A	32	350	382	70	58,10	2
PH007B	25	250	275	45	49,30	2

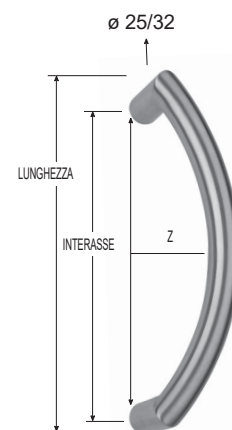

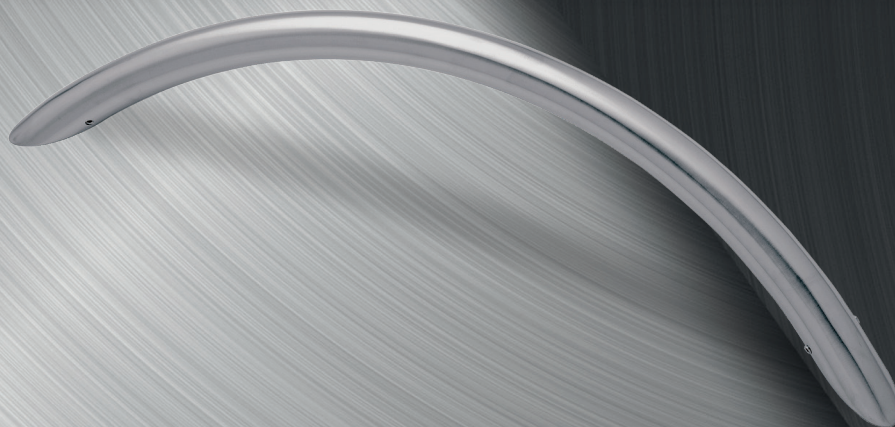

**PH008**

Maniglione INOX

*SS Pull handle*

CODE	Ø	INTERASSE	LUNGHEZZA	Z	€	PCS/BOX
PH008A	32	500	575	100	79,20	2
PH008B	32	600	680	105	85,80	2
PH008C	32	700	780	110	94,60	2

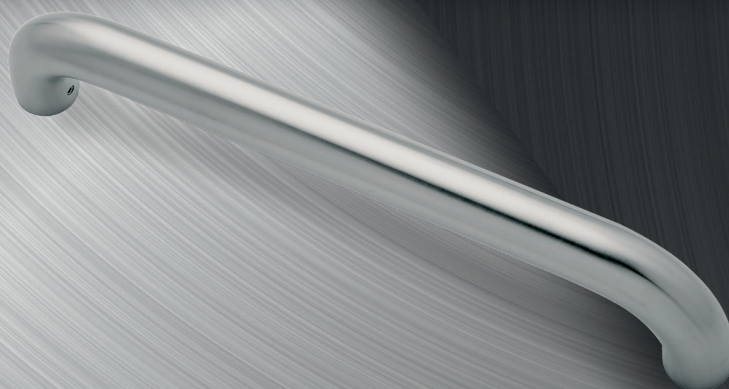
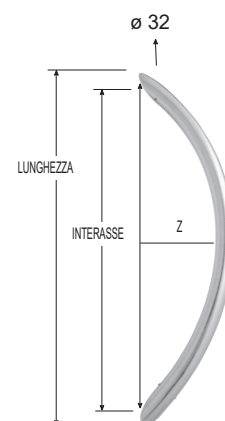

**PH001**

Maniglione INOX

*SS Pull handle*

CODE	Ø	INTERASSE	LUNGHEZZA	€	PCS/BOX
PH001	32	350	382	42,80	2



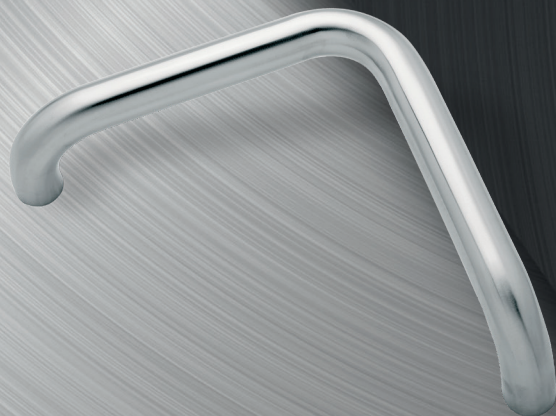

**PH005**

Maniglione INOX

*SS Pull handle*

CODE	Ø	INTERASSE	LUNGHEZZA	Z	€	PCS/BOX
PH005	32	350	382	150	58,10	2

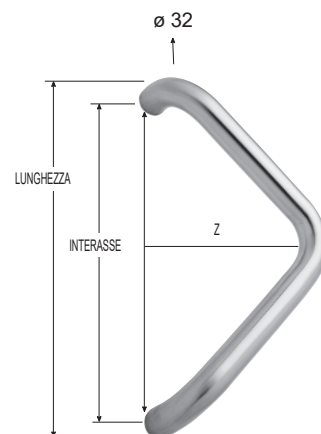

**PH002**

Maniglione INOX

*SS Pull handle*

CODE	Ø	INTERASSE	LUNGHEZZA	Z	€	PCS/BOX
PH002A	32	350	382	120	60,80	2
PH002B	25	350	375	80	58,60	2
PH002C	25	250	275	90	45,40	2

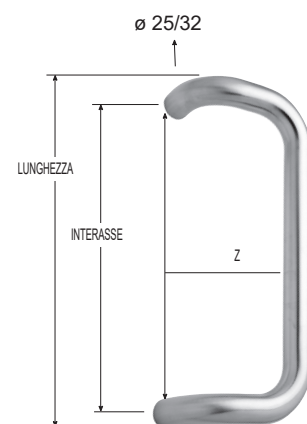

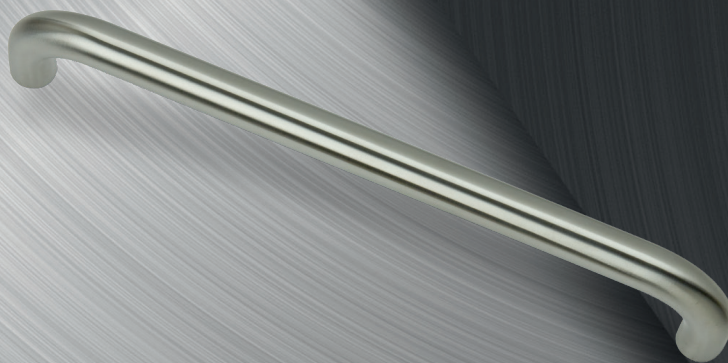

**PH001B**

Maniglione INOX

*SS Pull handle*

CODE	Ø	INTERASSE	LUNGHEZZA	€	PCS/BOX
PH0001B1	20	200	220	16,20	2
PH0001B2	20	250	270	17,80	2
PH0001B3	20	300	320	19,30	2

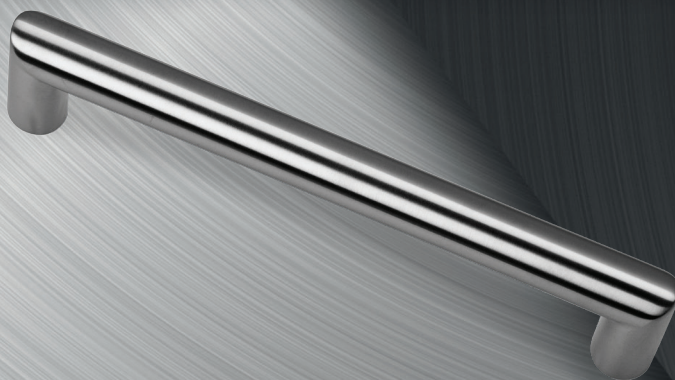
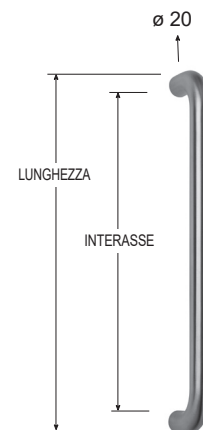

**PH021B**

Maniglione INOX

*SS Pull handle*

CODE	Ø	INTERASSE	LUNGHEZZA	€	PCS/BOX
PH0021B1	20	200	220	20,00	2
PH0021B2	20	250	270	21,60	2
PH0021B3	20	300	320	23,10	2
PH0021B4	20	400	420	24,70	2

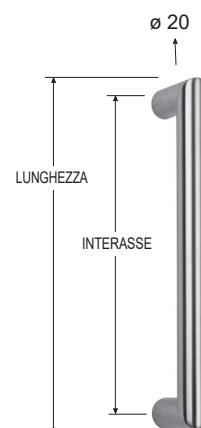

INOX  
SATINATO  
AISI  
304

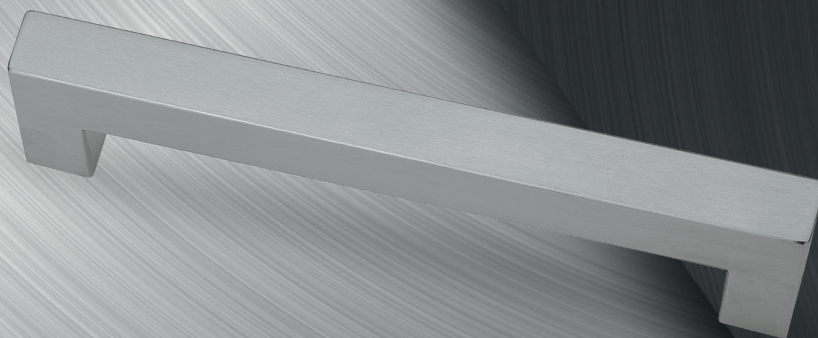

**PH031B**

Maniglione INOX

*SS Pull handle*

CODE	☒	INTERASSE	LUNGHEZZA	€	PCS/BOX
PH0031B1	20x20	200	220	24,70	2
PH0031B2	20x20	250	270	27,00	2
PH0031B3	20x20	300	320	29,30	2
PH0031B4	20x20	400	420	34,70	2

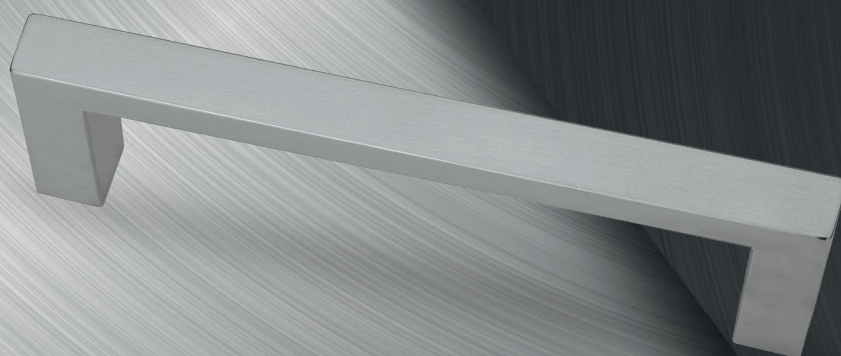
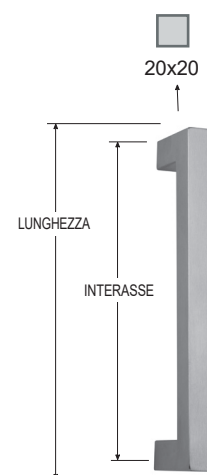

INOX  
SATINATO  
AISI  
304

**PH041B**

Maniglione INOX

*SS Pull handle*

CODE	☒	INTERASSE	LUNGHEZZA	€	PCS/BOX
PH0041B3	20x10	300	320	30,30	2
PH0041B4	20x10	400	420	35,70	2

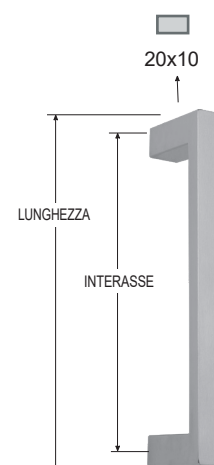



**PH016SB**

Maniglione INOX

SS Pull handle

CODE	∅	∅ GAMBI DRIITTI	INTERASSE	LUNGHEZZA	€	PCS/BOX
PH016SB1	25X25	20x20	210	300	93,50	2
PH016SB2	25X25	20x20	300	400	102,20	2
PH016SB3	25X25	20x20	300	500	110,90	2
PH016SB4	25X25	20x20	400	600	119,80	2
PH016SB5	25X25	20x20	600	800	132,80	2
PH016SB6	25X25	20x20	900	1200	172,60	2

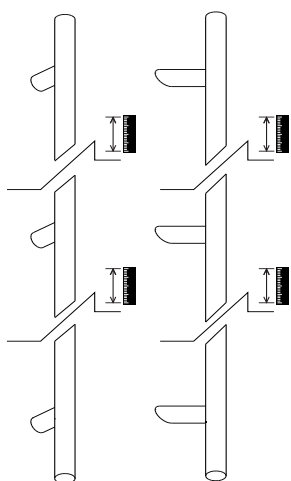
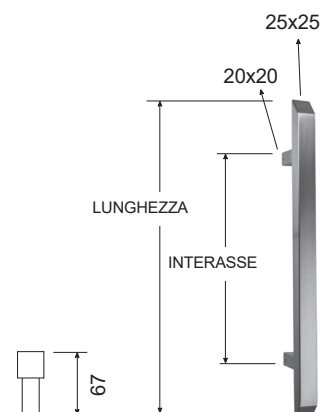

SI REALIZZANO SU RICHIESTA  
MANIGLIONI SU MISURA  
CON 2 O PIÙ SUPPORTI

ON REQUEST  
CUSTOM-MADE PULL HANDLES  
WITH 2 OR MORE SUPPORT



**MANIGLIONE TONDO DIRITTO**  
**STRAIGHT ROUND PULL HANDLE**

ART. PH006B - ART. PH006D - ART. PH006F

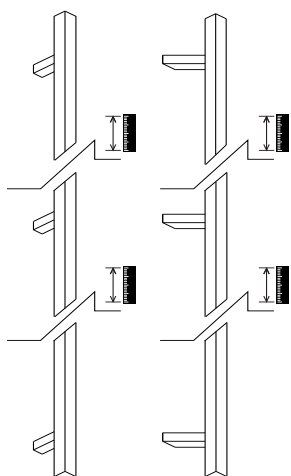

**MANIGLIONE TONDO INCLINATO**  
**SLANTED ROUND PULL HANDLE**

ART. PH006A - ART. PH006C - ART. PH006E

**MANIGLIONE QUADRO DIRITTO**  
**STRAIGHT SQUARE PULL HANDLE**

ART. PH006SB

**MANIGLIONE QUADRO INCLINATO**  
**SLANTED SQUARE PULL HANDLE**

ART. PH006SA

SI REALIZZANO  
SU RICHIESTA FINITURE

ON REQUEST FINISHES



GRF  
Grafite  
Graphite



NEO  
Nero Ral 9005 opaco  
Matt black



BAO  
Bianco Ral 9016 opaco  
Matt white



# KIT DI FISSAGGIO

## Fixing system

**kts**

CODICE e DESCRIZIONE CODE and DESCRIPTION	€	PCS/BOX	
<b>KIT01</b>			
Fissaggio doppio universale	13,20	1	
<b>KIT02</b>			
Fissaggio singolo legno/alluminio passante	19,50	1	
<b>KIT03</b>			
Fissaggio singolo legno non passante	8,25	1	
<b>KIT04</b>			
Fissaggio singolo alluminio non passante (taglio termico)	14,30	1	
<b>KIT05</b>			
Fissaggio singolo alluminio non passante (senza taglio termico)	23,65	1	

# Accessori - Accessories



# Maniglioni alzanti

## Pull handles for sliding doors

ktb

INOX  
SATINATO  
AISI  
304



CODICE e DESCRIZIONE  
CODE and DESCRIPTION

€

PCS/BOX

### PHB001

Maniglione alzante  
inox con nicchia

74,25

1

*Single Pull handle  
for sliding door*



### PHB001SET

Coppia maniglioni  
alzanti inox

110,40

1

*Pull handles Set  
for sliding door*



### PHB001PZ

Maniglione alzante inox  
foro cilindro con nicchia

76,25

1

*Single Pull handle  
for sliding door  
(cylinder hole)*



### PHB001PZSET

Coppia maniglioni alzanti  
inox foro cilindro

114,40

1

*Pull handles Set  
for sliding door  
(cylinder hole)*

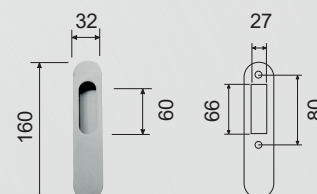
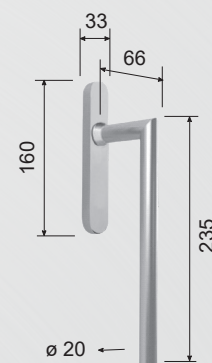
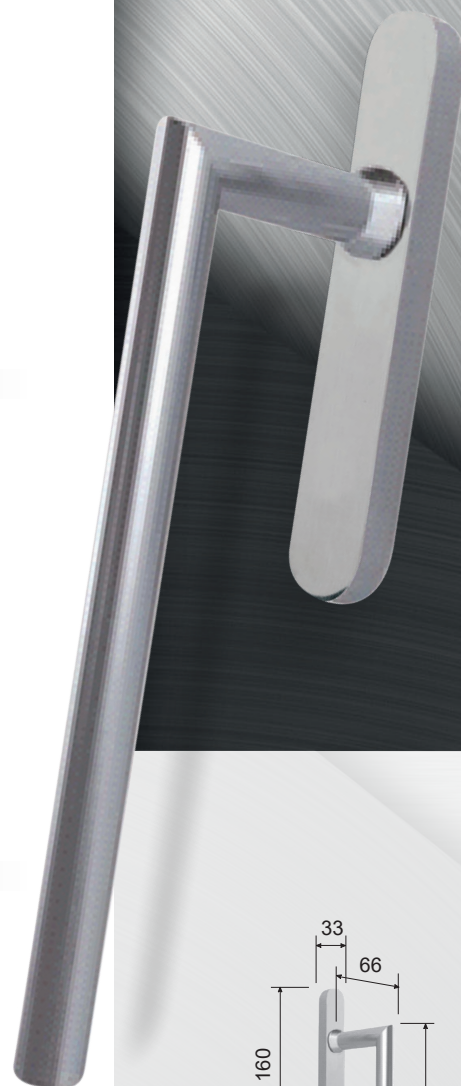

# Maniglioni alzanti

## Pull handles for sliding doors

**ktb**

INOX  
SATINATO  
AISI  
304



CODICE e DESCRIZIONE  
CODE and DESCRIPTION

€

PCS/BOX

### PHB002

Maniglione alzante  
inox con nicchia

74,25

1

*Single Pull handle  
for sliding door*



### PHB002SET

Coppia maniglioni  
alzanti inox

110,40

1

*Pull handles Set  
for sliding door*



### PHB002PZ

Maniglione alzante inox  
foro cilindro con nicchia

76,25

1

*Single Pull handle  
for sliding door  
(cylinder hole)*



### PHB002PZSET

Coppia maniglioni alzanti  
inox foro cilindro

114,40

1

*Pull handles Set  
for sliding door  
(cylinder hole)*

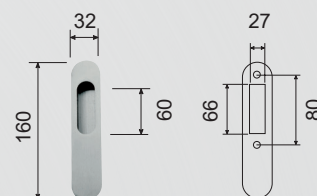
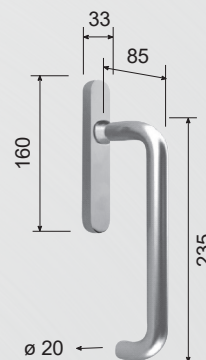
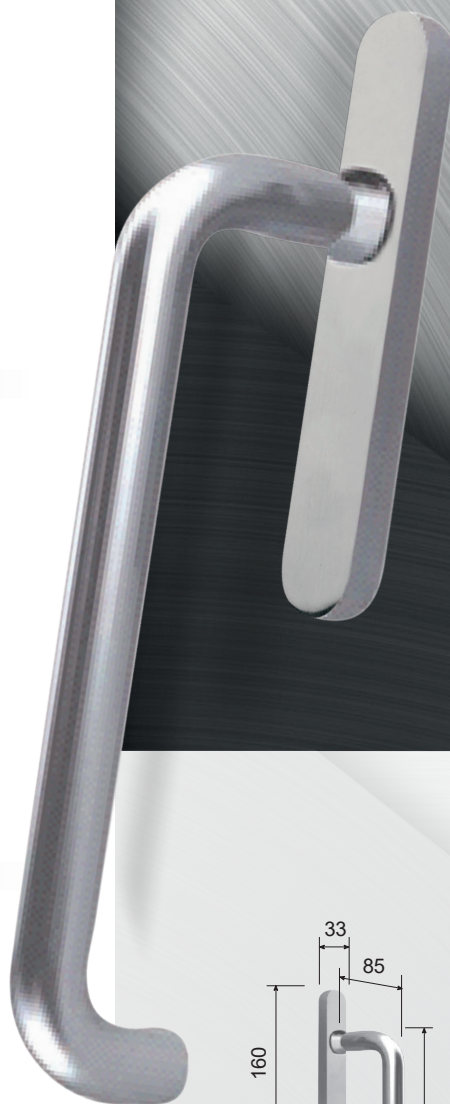

# Maniglioni alzanti

## Pull handles for sliding doors

**kts**

INOX  
SATINATO  
AISI  
304



CODICE e DESCRIZIONE  
CODE and DESCRIPTION

€

PCS/BOX

### PHB003

Maniglione alzante  
inox con nicchia

74,25

1

*Single Pull handle  
for sliding door*



### PHB003SET

Coppia maniglioni  
alzanti inox

110,40

1

*Pull handles Set  
for sliding door*



### PHB003PZ

Maniglione alzante inox  
foro cilindro con nicchia

76,25

1

*Single Pull handle  
for sliding door  
(cylinder hole)*



### PHB003PZSET

Coppia maniglioni alzanti  
inox foro cilindro

114,40

1

*Pull handles Set  
for sliding door  
(cylinder hole)*

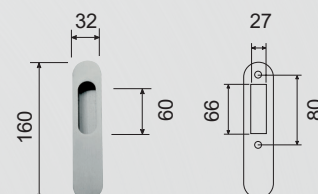
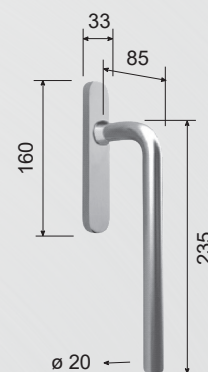

# Maniglioni alzanti

## Pull handles for sliding doors

**kts**

INOX  
SATINATO  
AISI  
304



CODICE e DESCRIZIONE  
CODE and DESCRIPTION

€

PCS/BOX

### PHB004

Maniglione alzante  
inox con nicchia

116,60

1

*Single Pull handle  
for sliding door*



### PHB004SET

Coppia maniglioni  
alzanti inox

211,80

1

*Pull handles Set  
for sliding door*



### PHB004PZ

Maniglione alzante inox  
foro cilindro con nicchia

119,60

1

*Single Pull handle  
for sliding door  
(cylinder hole)*



### PHB004PZSET

Coppia maniglioni alzanti  
inox foro cilindro

217,80

1

*Pull handles Set  
for sliding door  
(cylinder hole)*

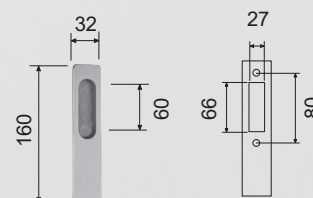
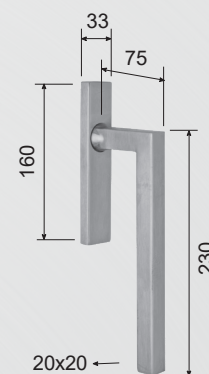
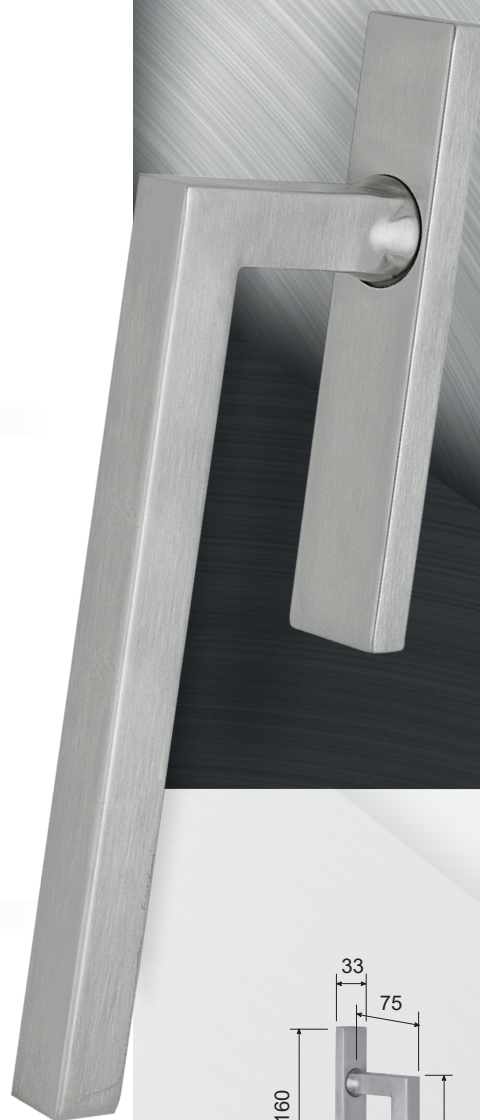

CODICE e DESCRIZIONE CODE and DESCRIPTION	FINITURE FINISHINGS	€	PCS/BOX
<b>KN01ARR02</b>			
Pomolo SFERA ø 50 mm su rosetta ø 50 mm	INOX AISI 304 SATINATO	33,55	4
<i>SFERA knob ø 50 mm square rose ø 50 mm</i>			



<b>KN01BRR02</b>			
Pomolo SFERA ø 70 mm su rosetta ø 50 mm	INOX AISI 304 SATINATO	48,50	4
<i>SFERA knob ø 70 mm square rose ø 50 mm</i>			



<b>KN04RR02</b>			
Pomolo YORK ø 70 mm su rosetta ø 50 mm	INOX AISI 304 SATINATO	48,50	4
<i>YORK knob ø 70 mm square rose ø 50 mm</i>			





CODICE e DESCRIZIONE CODE and DESCRIPTION	FINITURE FINISHINGS	€	PCS/BOX	
<b>KN02RR02</b>				
Pomolo FLAT ø 52 mm su rosetta ø 50 mm	INOX AISI 304 SATINATO	33,55	4	
<i>FLAT knob ø 52 mm square rose ø 50 mm</i>				
<b>KN03ARR02</b>				
Pomolo QUADRO 50x50 mm su rosetta ø 50 mm	INOX AISI 304 SATINATO	43,50	4	
<i>QUADRO knob 50x50 mm square rose ø 50 mm</i>				
<b>KN03BSR01</b>				
Pomolo SQUARE 50x50 mm su rosetta 50x50 mm	INOX AISI 304 SATINATO	53,50	4	
<i>SQUARE knob 50x50 mm square rose 50x50 mm</i>				



# NOTTOLINO WC

## Wc turns & releases

**kts**

CODICE e DESCRIZIONE CODE and DESCRIPTION	FINITURE FINISHINGS	€	PCS/BOX
<b>KRR01WCA</b>			
Nottolino libero/occupato per porta battente su rosetta tonda ø 52 mm con finestra	INOX AISI 304 SATINATO	21,50	1
<i>Wc closer with round rose ø 52 mm with window</i>			
			
<b>KRR01WCB</b>			
Nottolino libero/occupato per porta battente su rosetta tonda ø 52 mm senza finestra	INOX AISI 304 SATINATO	21,00	1
<i>Wc closer with round rose ø 52 mm without window</i>			
			
<b>KSR01WCB</b>			
Nottolino libero/occupato per porta battente su rosetta quadra 50x50 mm senza finestra	INOX AISI 304 SATINATO	26,40	1
<i>Wc closer with square rose 50x50 mm without window</i>			
			

# NOTTOLINO WC

## Wc turns & releases



CODICE e DESCRIZIONE CODE and DESCRIPTION	FINITURE FINISHINGS	€	PCS/BOX
----------------------------------------------	------------------------	---	---------

### KOR01WCA

Nottolino libero/occupato  
per porta battente  
su rosetta ovale 30x60 mm  
con finestra

INOX  
AISI 304  
SATINATO

22,60

1

*Wc closer with oval  
rose 30x60 mm  
with window*



### KOR01WCB

Nottolino libero/occupato  
per porta battente  
su rosetta ovale 30x60 mm  
senza finestra

INOX  
AISI 304  
SATINATO

22,00

1

*Wc closer with oval  
rose 30x60 mm  
without window*



### KQR01WCB

Nottolino libero/occupato  
per porta battente  
su rosetta rettangolare 30x60 mm  
senza finestra











INOX  
AISI 304  
SATINATO

28,60

1

*Wc closer with rectangular  
rose 30x60 mm  
without window*



CODICE e DESCRIZIONE CODE and DESCRIPTION	FINITURE FINISHINGS	€	PCS/BOX	
<b>KRR01PZ KRR01OB</b>				
Bocchetta tonda ø 52 mm con foro yale / foro chiave  <i>Round escutcheon ø 52 mm with pz hole / key hole</i>	INOX AISI 304 SATINATO	3,70	1	
				 
				<p style="text-align: center;"><b>KRR01PZ</b>                      <b>KRR01OB</b></p>
<b>KSR01PZ KSR01OB</b>				
Bocchetta quadra 50x50 mm con foro yale / foro chiave  <i>Square escutcheon 50x50 mm with pz hole / key hole</i>	INOX AISI 304 SATINATO	5,00	1	
				 
				<p style="text-align: center;"><b>KSR01PZ</b>                      <b>KSR01OB</b></p>
<b>KOR01PZ KOR01OB KOR01CO</b>				
Bocchetta ovale 30x60 mm con foro yale / foro chiave foro cilindro ovale  <i>Oval escutcheon 30x60 mm with pz hole / key hole oval cylinder hole</i>	INOX AISI 304 SATINATO	4,20	1	
				  
				<p style="text-align: center;"><b>KOR01PZ</b>                      <b>KOR01OB</b>                      <b>KOR01CO</b></p>
<b>KQR01PZ KQR01OB KQR01CO</b>				
Bocchetta rettangolare 30x60 mm con foro yale / foro chiave foro cilindro ovale  <i>Rectangular escutcheon 30x60 mm with pz hole / key hole oval cylinder hole</i>	INOX AISI 304 SATINATO	5,40	1	
				  
				<p style="text-align: center;"><b>KQR01PZ</b>                      <b>KQR01OB</b>                      <b>KQR01CO</b></p>

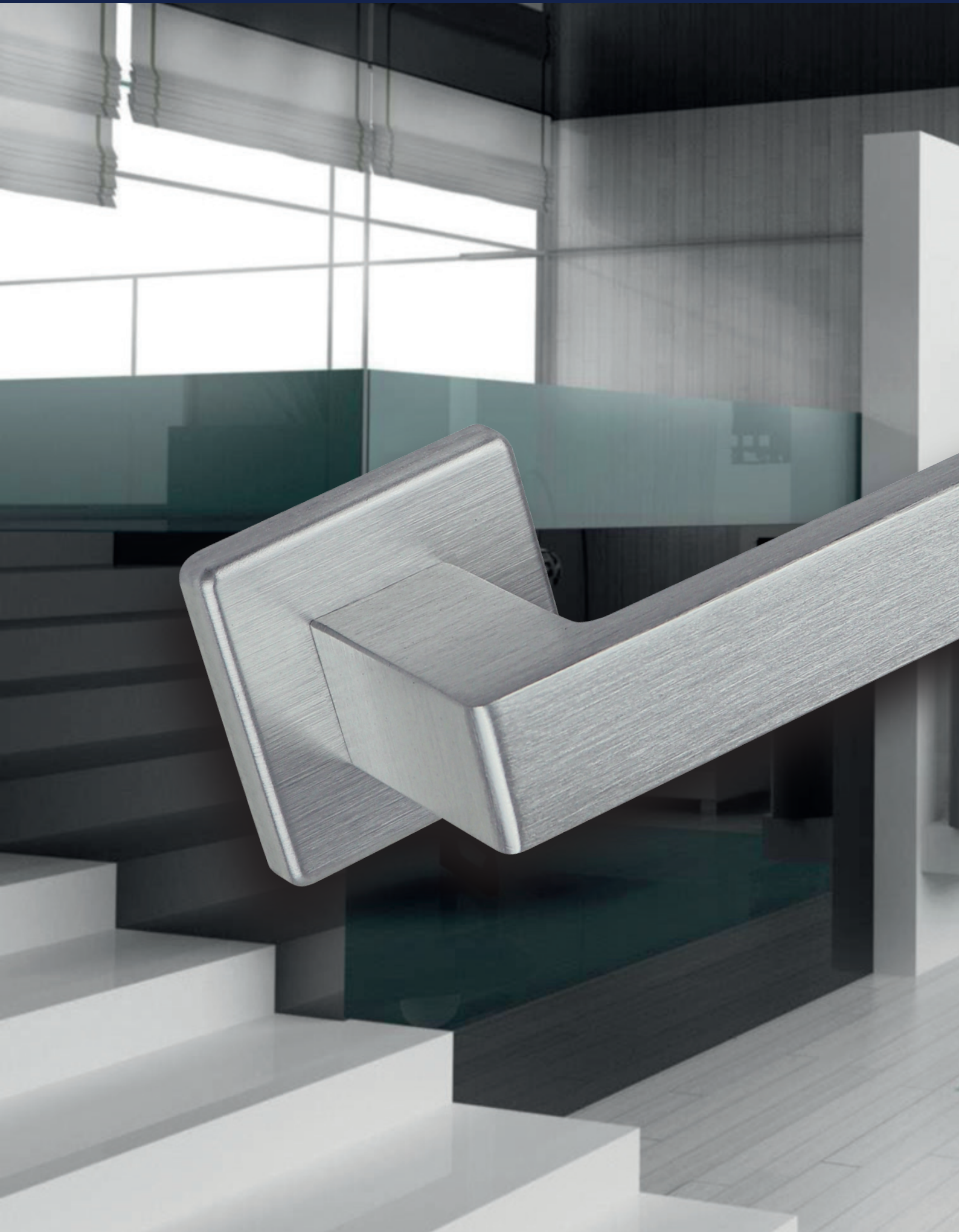



# WILLY ALU

CODICE e DESCRIZIONE  
CODE and DESCRIPTION

FINITURE  
FINISHINGS

€

PCS/BOX

## LHA017SR17

Maniglia su rosetta quadra  
*Handle with square rose*

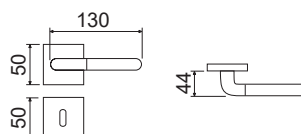

F1S	26,80	1
F4S	26,80	1
BAO	29,00	1
NEO	28,00	1

## LHA017DK04

Martellina DK  
con movimento in fibra  
*DK window handle*

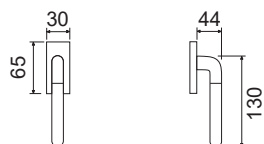

F1S	16,10	4
F4S	16,10	4
BAO	17,40	4
NEO	16,80	4



# ORIONE ALU

CODICE e DESCRIZIONE  
CODE and DESCRIPTION

FINITURE  
FINISHINGS

€

PCS/BOX

## LHA002RR09

Maniglia su rosetta tonda  
*Handle with round rose*

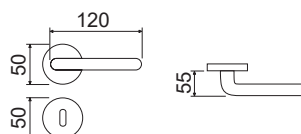

F1	14,00	1
F4	14,00	1

Espositore a parete 150x31,5 cm

---



Espositore da banco per 6 maniglie 22x30 cm

---





**kts**  
**Italia**



# Condizioni generali di vendita

## General conditions of Sale



### Prezzi

I prezzi si intendono per merce resa nostra fabbrica ed al netto di ogni spesa accessoria (trasporto, imballo, spese postali, incasso, ect.), riferiti a cadaun pezzo o coppia, in caso di maniglie e di pomoli, in EURO IVA esclusa. Ci riserviamo la facoltà di modificare prezzi e condizioni generali di vendita in qualsiasi momento ed a nostro insindacabile giudizio, senza alcun obbligo di preavviso. I prezzi indicati sono validi fino al 01.07.2020. Dopo tale data ogni cliente è tenuto ad informarsi, per ogni ordine, degli eventuali nuovi prezzi.

### Ordinazioni

Gli ordini diretti o indiretti si considerano assunti solo dopo nostra accettazione. I quantitativi ordinati devono essere conformi alle nostre confezioni standard. Le quantità non conformi alle confezioni o le produzioni disponibili a richiesta, se accettate, saranno soggette ad una maggiorazione non inferiore al 25% del prezzo di listino. Il minimo spedibile è di 250,00 netto.

### Consegna

I termini di consegna hanno unicamente valore indicativo e si riferiscono alla data di consegna della merce al vettore. Non sono ammessi annullamenti o modifiche durante l'esecuzione dell'ordine che ha inizio al momento del suo ricevimento. La mancata o ritardata esecuzione di una parte o di tutto l'ordine, per cause di forza maggiore, non potrà dare diritto al Committente di annullare l'ordine stesso o di richiedere il risarcimento di eventuali danni.

### Pagamenti

I pagamenti sono validi unicamente se eseguiti alla nostra Sede amministrativa in Treviso Bresciano (BS). Trascorso il termine stabilito in fattura per il pagamento decorrono di pieno diritto gli interessi di mora al tasso bancario. La presentazione di qualsiasi reclamo non dispensa il compratore dal pagamento della fattura alla scadenza stabilita. Il mancato pagamento di un ordine determina la sospensione senza preavviso di tutti gli ordini in corso ed il loro eventuale annullamento, fatto salvo il risarcimento dei nostri danni. Ci riserviamo il diritto di proprietà delle merci fornite fino all'avvenuto pagamento di tutti i crediti, inclusi interessi e costi.

### Imballi

Gli imballi vengono fatturati al prezzo di costo; l'importo è assoggettato ad IVA

### Spedizioni

La merce viene resa franco nostro stabilimento e viaggia a rischio e pericolo del Committente. La nostra responsabilità termina all'atto della consegna della merce al vettore. Il destinatario, a sua cura e spese, deve verificare i colli prima del ritiro ed in caso di avarie, rotture, ammacchi o furti, deve rivolgere i reclami al vettore, anche nel caso di merce recapitata in porto franco.

### Varie

Non si accettano resi di merce se non espressamente autorizzati, restituiti in imballo originale o idoneo a conservarlo perfettamente integro e franchi di ogni spesa al magazzino della nostra Sede. Trascorsi 8 giorni dall'arrivo della merce a destino, le nostre fatture si intendono approvate ed accettate e nessun reclamo potrà più essere ammesso. Gli eventuali difetti sui prodotti o nostri errori di spedizione potranno impegnarci solo alla sostituzione od integrazione del materiale senza rifusione di eventuali danni. Ci riserviamo di apportare qualsiasi modifica ai prodotti, di sospenderli e/o eliminarli dalla produzione, senza obbligo di preavviso e ciò non ci impegnerà alla sostituzione dei materiali giacenti presso i clienti. Dati, misure e schemi hanno solamente carattere informativo e non vincolanti. Eventuali errori e/o refusi di stampa non costituiscono motivo di contestazione.

### Foro competente

Per qualsiasi controversia è competente il Foro di Brescia. Tutte le suddette condizioni si intendono tacitamente accettate col conferimento dell'ordine e qualunque condizione in deroga o comunque non contemplata nelle presenti " condizioni generali di vendita", sarà valida solo se risultante da accordo scritto.